

The
Union Switch & Signal Co.
Swissvale, Pa.

1909



Catalogue of
Electric Crossing Bell
Appliances

Catalogue and Price List
of
Electric Crossing Bell
Appliances

THE
UNION SWITCH & SIGNAL Co.
OF PITTSBURGH, PA.

Owners of the Westinghouse System of Electro-Pneumatic Block Signaling and Interlocking.

Also Designers, Manufacturers and Erectors of Pneumatic, Electro-Pneumatic, Electric, Electro-mechanical, and Purely Mechanical Appliances for Railway Protection.

Automatic, Semi-automatic and Manually Operated Block Signals.

Electro-Pneumatic, Electric and Mechanical Interlockings to suit conditions.

Plans and Estimates on Application.

General Offices and Works
SWISSVALE, PA.

New York **Chicago** **Montreal**
Central Bldg. **Monadnock Bldg.** **Commercial Union Bldg.**

THE UNION SWITCH & SIGNAL COMPANY'S
PUBLISHING DEPARTMENT
Swissvale, Pa.

Press of
MURDOCH, KERR & Co.
Pittsburgh, Pa.
426

HIGHWAY CROSSING BELL

This Catalogue is issued to supersede Bulletin 24 and illustrates our latest and most improved Direct and Alternating Current Highway Crossing Bell Apparatus.

On page 4 will be found the information which is required for making proposals for D. C. installations, and page 37, for A. C. installations; on page 5, suggestions with regard to installation; on pages 6 and 7, suggestions for the guidance of inspectors and maintainers. Diagrams and description of single and double track D. C. crossing bell layouts will be found on pages 28 to 36 inclusive, and of A. C. Layouts on pages 44 to 47 inclusive.

The Union Switch & Signal Company.

Swissvale, Pa., June, 1909.

ORDERS

When ordering material from this catalogue, the Plate and Figure number should be given in all cases; also, such other information as may be called for in the notes or lists.

INFORMATION REQUIRED FOR MAKING PROPOSALS

FIRST. A topographical scale plan showing the streets or highways to be protected, the tracks crossing them for at least a distance of 1,500 feet on either side of the farthest street or highway, and the location of all switches and railroad crossings within the above limits is desirable, or a sketch plan will answer in lieu of the former.

SECOND. Plans should also indicate the points at which it is desired to start and stop each bell by the movement of trains on each track, unless it is the intention to leave these matters to our judgment, in which case the maximum speed of trains and direction of traffic on each track should be furnished.

THIRD. The proposed location of each bell with reference to the tracks and streets or highways should be indicated.

FOURTH. Any special information concerning the control of the bells by crossing tenders, switchmen, telegraph operators or others, when such are required; or any special train control as in yards or where switching movements are made.

FIFTH. Any other information of a general nature pertaining to the proposed installation, remembering that we are not acquainted with local conditions.

TABLE OF THE TIME REQUIRED TO RUN A GIVEN DISTANCE AT A CERTAIN SPEED

Speed in Miles Per Hour	Feet Per Second	Seconds to Run 1500 Ft.	Seconds to Run 2000 Ft.	Seconds to Run $\frac{1}{2}$ Mile
20	29	52	68	90
30	44	34	46	60
40	59	26	34	45
50	73	20	27	38
60	88	17	23	30
70	102	15	19	26
80	117	13	17	22

SUGGESTIONS WITH REGARD TO INSTALLATION

Railroad Companies maintaining a signal department usually find it cheaper to purchase their crossing bell material from us and install it with their own forces, thereby saving the cost of transporting our men and tools from headquarters to the site of installation and return, as well as the profit which we naturally expect to make on erection labor.

Purchasers having no such department find it profitable to call on us to furnish a foreman at a fixed rate of pay to superintend the installation and to draw from their Telegraph or Maintenance of Way Department the necessary men to assist him.

If it is desired, we will furnish free of cost such plans or wiring diagrams as are necessary for the installation of apparatus of our manufacture. These diagrams are so drawn as to be easily followed by the average signal repairman or lineman.

MAINTENANCE AND INSPECTION

The following are a few simple rules and suggestions for the guidance of maintainers:

FIRST. Keep your track battery strong and in good order, inspecting same semi-monthly.

SECOND. A gravity cell deteriorates through the action of the blue vitriol solution upon the zinc element forming a whitish solution of zinc sulphate. When the line of demarkation is central, the cell is prime. If the white solution gets too near the vitriol, draw off some of the zinc sulphate by means of a battery syringe and add soft water and vitriol. If the copper sulphate gets too high, draw off some of the blue solution and replace by water, care being taken to wash the zincs and scrape all connections in every case.

THIRD. Watch your track and keep the insulation good. If gravel, cinder or dirt ballast is used, do not allow it to lay up over the base of the rails, which will cause leakage. Test your insulated joints to insure their good condition. Look after your bond wires and taps where insulated wires lead off from track. These are often broken or corroded off, and this is apparent only upon trying the wire by a slight pull.

FOURTH. If bond wires are put between the splice bars and the rail, be especially watchful along damp or wet track. A broken bond behind a splice may open up in the cool hours of the night and close again in the hot hours of the day, thereby making an intermittent failure sometimes hard to find.

FIFTH. Allow slack wire in bends, in trunking.

SIXTH. Do not use soldering salts to corrode the joints. Use our non-acid soldering compound that will not injure the wire.

SEVENTH. Do not attempt to adjust the track relay, but return it to us with seal unbroken with a report of the trouble in the relay mechanism.

EIGHTH. Do not use gas pliers or other heavy instrument on the thumb screws or binding posts of relays, bells, lightning arresters, etc. They are not constructed to stand rough treatment.

NINTH. In fastening lightning arresters to support, be sure to get a good even bearing or you will break the porcelain core.

TENTH. Keep your bell and all apparatus well painted to preserve them from rust and decay.

ELEVENTH. In case of trouble, localize the fault and then test out. Do not hunt at random. If your track relay is working, you know the fault is beyond the track and its connections.

TWELFTH. Sweep your hand lightly over the battery connections to pick out the weak ones, usually due to corrosion from creeping salts.

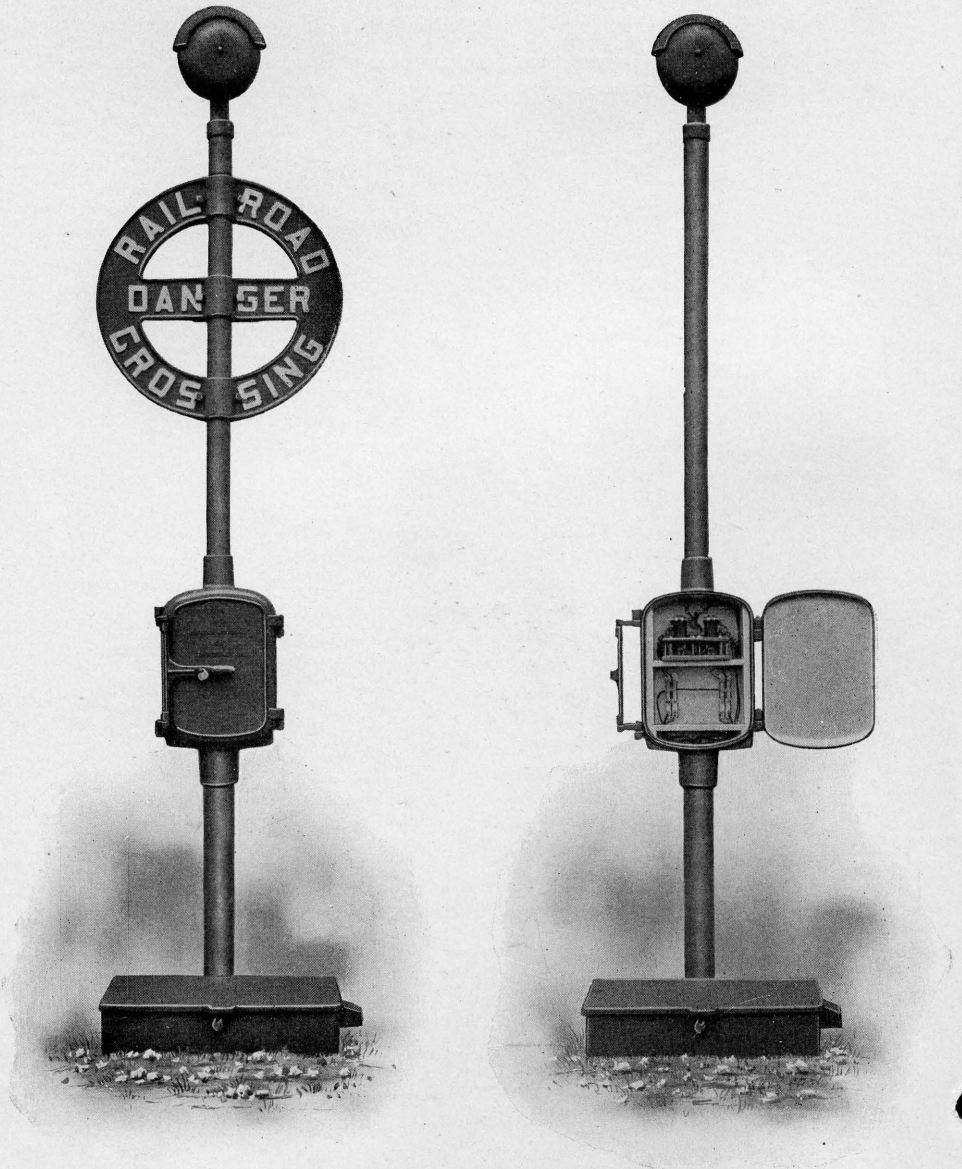

THE UNION ELECTRIC DIRECT CURRENT CROSSING BELL,
(MOUNTED ON IRON PIPE POST)

**THE UNION ELECTRIC DIRECT CURRENT
CROSSING BELL
(MOUNTED ON IRON PIPE POST)**

The illustrations on the opposite plate represent two arrangements of bells for use at grade crossings in which cheapness, without sacrifice of quality, is combined with flexibility of assemblage and neatness of design.

Should the state law require a special sign at highways, it is an easy matter to apply one to the 3" mast of the bell support, or the user's own standard may be substituted. If a sign is not desired, its omission will not materially affect the appearance of the equipment.

It is not always necessary that relay or battery shelters be part of the outfit, as there may be suitable shelter for these at hand, in which event they may be omitted.

The bell is as nearly water proof as is possible. A twelve-inch steel gong is fitted to a cast iron back plate on the bottom of which is a collar to take a three-inch casing, and in the back a pocket with a cover plate protects the electro-magnets. The tapper is mounted on an extension stud and operates between the back plate and the gong, being nearly hidden from view. A cast iron hood that turns all rain or snow from the bell is bolted over the top of the gong; the whole forming a very compact arrangement.

The sign is a cast iron ring three feet in diameter with letters four inches in height cast on each face. It is made up of two sections bolted together and so arranged and lettered that the two pieces are identical.

The relay box is capable of holding two direct current inclosed interlocking relays and eight lightning arresters. It embodies all the features of our standard cast iron relay shelters shown in Section 13.

The battery shelter consists of a cast iron box and cover large enough to hold eight cells of primary battery.

All wires from battery, line, or track, to relays or bell are run inside of the hollow iron post and thereby protected from malicious or accidental injury.

We recommend this type of installation on account of its durability and the protection afforded the mechanism and connections. The steel gong meets all the requirements of the bell metal gong, besides being cheaper in first cost.

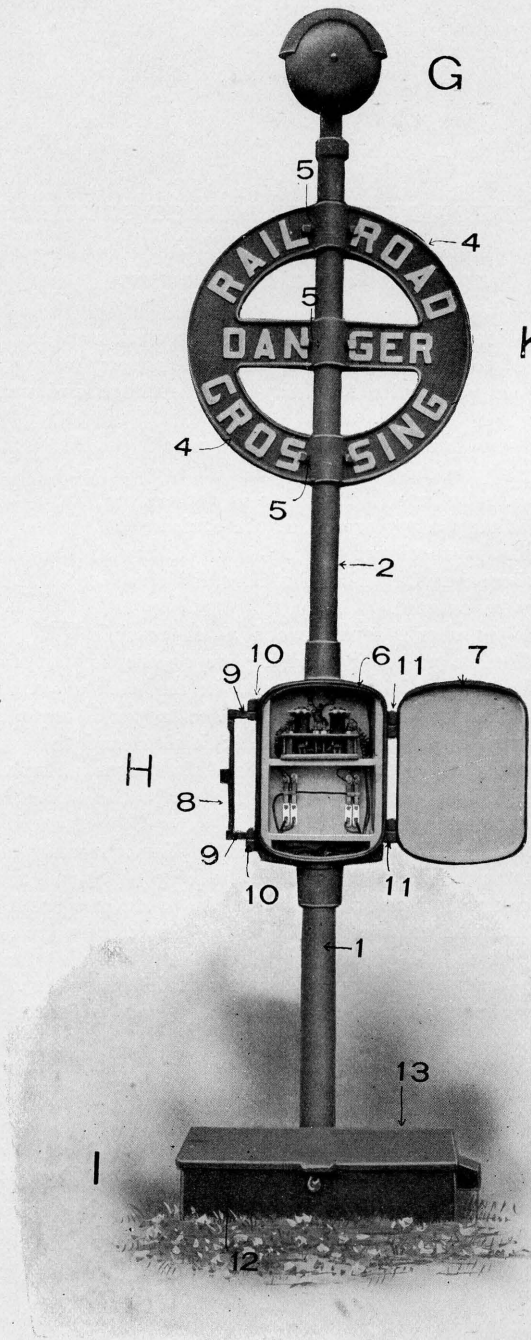

THE UNION ELECTRIC DIRECT CURRENT CROSSING BELL
(MOUNTED ON IRON PIPE POST)

**THE UNION ELECTRIC DIRECT CURRENT CROSSING BELL
(MOUNTED ON IRON PIPE POST)**

For detail of bell see Plate 2405.
When ordering specify resistance of magnets.

Order by Plate, Figure and Instructions given above

The drawing references are shown merely for convenience in checking material with shipping lists and invoices.

Fig.		Drawing Reference	List Price
A	Combined Bell, Bell Post, Sign, Relay Box and Battery Box, as shown. (No relay or lightning arresters)	1-B-8912	120 00
B	Combined Bell, Bell Post, Relay Box and Battery Box. (No sign)	"	109 00
C	Combined Bell, Bell Post, Sign and Relay Box. (No battery box)	"	93 00
D	Combined bell, Bell Post and Relay Box. (No battery box or sign)	"	81 40
E	Combined Bell, Bell Post and Sign. (No relay box or battery box)	"	73 10
F	Combined Bell and Bell Post. (No sign, battery box or relay box)	"	61 50
G	D. C. Crossing Bell. See Plate 2405	C-7376	44 50
H	Relay Box with wood lining, shelves and lock. (No relay or lightning arrester)	1-B-9636	25 50
I	Battery Box with bottom board and lock. (No batteries)	4-B-7253	26 60
K	Sign, with bolts and nuts, (1-4, 6-5)	C-5844	11 00
L	Post only 18' 6" long, 3" and 4" Sections for Fig. E. or F. or for use with pinnacle B Plate 2409 and clamped to relay box		17 00
1	Lower Post, 4" casing	13-B-9893	5 90
2	Upper Post, 3" casing	117-B-5161	4 40
4	Half of Sign. Specify which half is required	C-5844	5 50
5	Hex. Hd. Bolt and Nut, $\frac{5}{8}$ "x2- $\frac{3}{4}$ ", for fastening sign Fig. 4 to post Fig. 2		08
6	Relay Box only	6-D-783	13 50
6a	as above, with rubber gasket		15 10
7	Door, with staple only	1-D-783	3 90
8	Hasp for relay box Fig. 6	4-B-8299	48
9	Link for hasp Fig. 8	7-D-783	14
10	Special pin for fastening link Fig. 9 to relay box Fig. 6	46-B-8058	05
11	Rd. Hd. Iron Rivet, $\frac{3}{8}$ "x3- $\frac{1}{4}$ ", for fastening door Fig. 7 to relay box Fig. 6		02
12	Battery Box (capacity 8 cells Edison primary batteries, type "R. R.")	1-C-5043	19 40
13	Cover for battery box Fig. 12	2-C-5043	5 30
14	Lining and Shelving for relay box Fig. 6	2-C-6969	1 20
15	Sq. Hd. Steel Set Screw, $\frac{5}{8}$ "x1", for fastening bell Fig. G to post Fig. 2 and relay box Fig. H to post Fig. 1		04

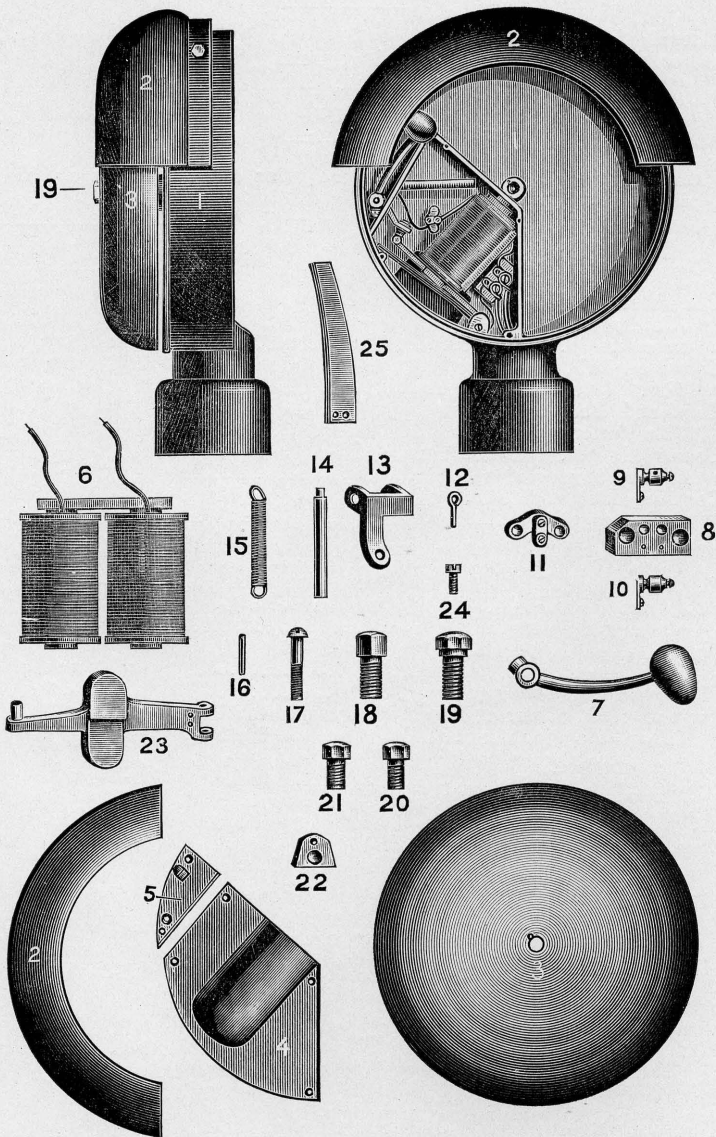

THE UNION ELECTRIC DIRECT CURRENT CROSSING BELL

THE UNION ELECTRIC DIRECT CURRENT CROSSING BELL

For application of bell see Plate 2403.
When ordering specify resistance of magnets.

Order by Plate, Figure and Instructions given above

The drawing references are shown merely for convenience in checking material with shipping lists and invoices.

Fig.		Drawing Reference	List Price
A	D. C. Crossing Bell, complete.....	C-7376	44 50
1	Case	1-C-7377	21 10
2	Cover	2-C-7377	4 45
3	Steel Gong, 12".....		5 20
4	Magnet Cover	3-C-7377	2 20
5	Plate Bearing for tapper shaft.....	7-C-7377	1 10
6	Magnets	30-C-7377	12 00
7	Tapper	24-C-7377	80
8	Hard Rubber Terminal Block.....	5-C-7377	80
9	Terminal Post	22-C-7377	62
10	Terminal Post	"	62
11	Fibre Terminal Block.....	17-C-7377	62
12	Eye for attaching spring Fig. 15 to operating arm Fig. 13		10
13	Operating Arm	6-C-7377	1 10
14	Shaft for tapper Fig. 7.....	23-C-7377	25
15	Spring for tapper Fig. 7.....	10-C-7377	35
16	Armature Shaft	20-C-7377	16
17	Rd. Hd. Mach. Screw, 1/4"-20x1 1/2", for fastening magnets Fig. 6 to case Fig. 1.....		16
18	Set Screw, 1/2"x1", for fastening case Fig. 1 to post.		
19	Special Tap Bolt, 1/2"x1 1/8", for fastening gong Fig. 3 to case Fig. 1.....	26-C-7377	32
20	Hex. Hd. Tap Bolt, 3/8"x5/8", for fastening cover Fig. 2 to case Fig. 1.....		32 16
21	Bolt, same as Fig. 20.....		16
22	Armature Trunnion	4-C-7377	23
23	Armature	29-C-7377	1 56
24	Fil. Hd. Mach. Screw, No. 6-32x1 1/2", for fastening terminal blocks Figs. 8 and 11 to case Fig 1....		10
25	Spring for armature Fig 23.....	21-C-7377	32

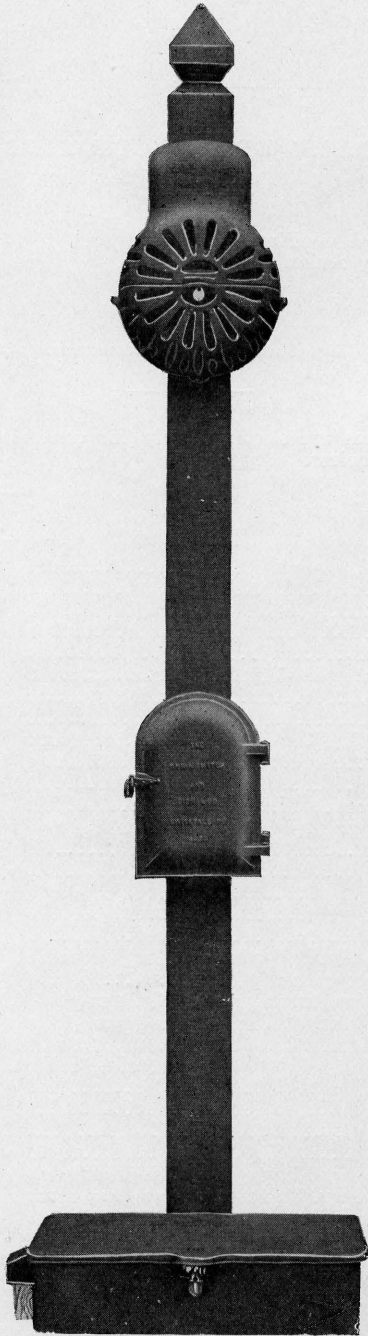

THE UNION ELECTRIC DIRECT CURRENT CROSSING BELL
(MOUNTED ON WOODEN POST)

**THE UNION ELECTRIC DIRECT CURRENT
CROSSING BELL**

(MOUNTED ON WOODEN POST)

For those who prefer to use a wooden post for their crossing bell support, we offer the equipment illustrated on the opposite plate.

The bell case (Fig. A, Plate 2409) is of cast iron of suitable weight and reinforced to guard against breakage in ordinary use. The electric mechanism of the bell is properly protected without impairing the sound of the gong. By removing the cover of the case, the complete mechanism of the bell (Fig. B, Plate 2411) is exposed, thus allowing any adjustment of the contact spring, hammer, etc., that may be necessary.

The connecting wires are carried through the back of the case from the rear of the post and are completely concealed from view.

The relay box is our standard cast iron type as applied to a wooden post and of capacity sufficient for one universal direct current enclosed interlocking relay.

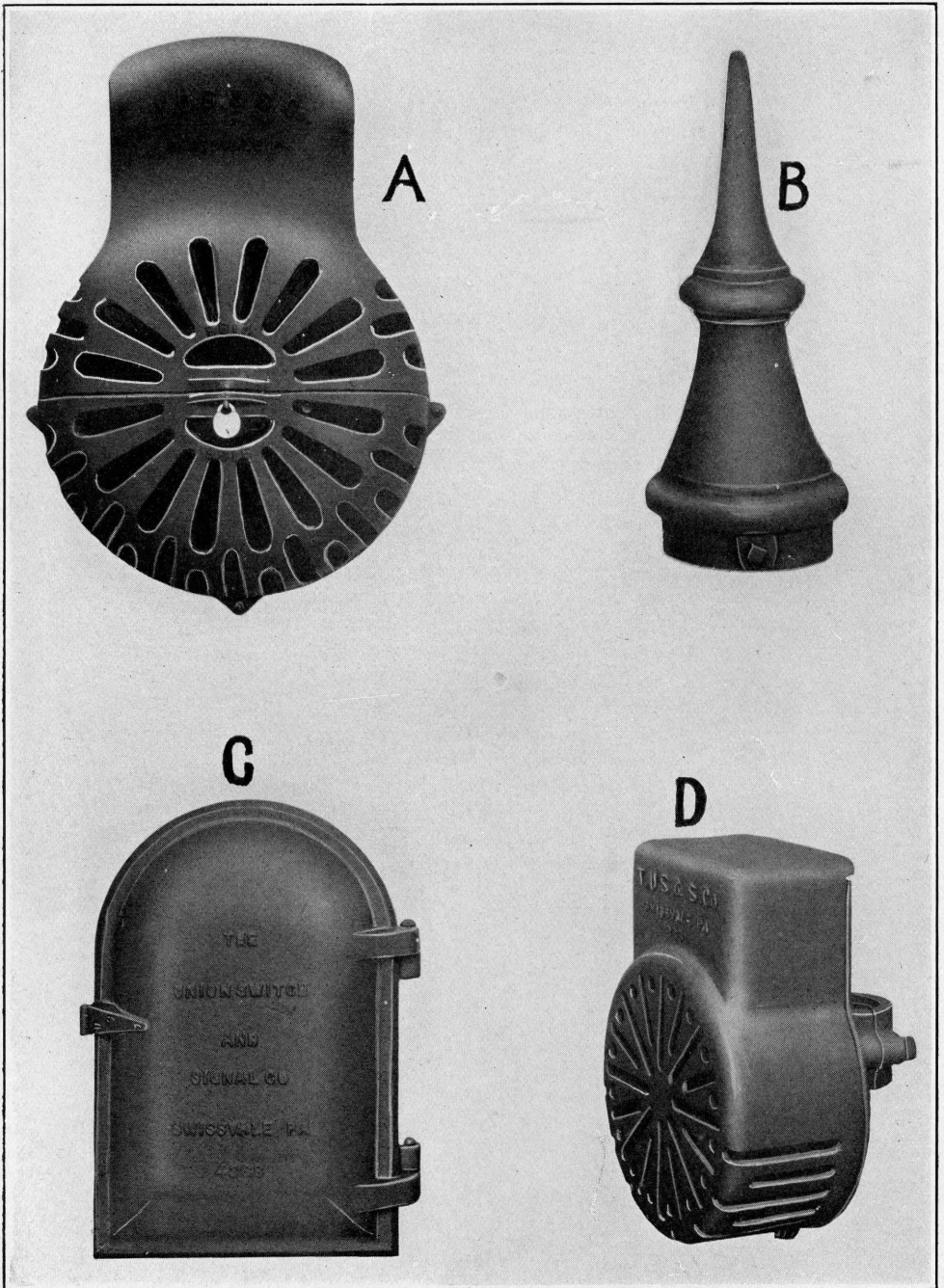

DIRECT CURRENT CROSSING BELL APPURTENANCES

DIRECT CURRENT CROSSING BELL APPURTENANCES

The opposite plate illustrates some of the main fittings of a crossing bell outfit. Fig. A is a case for use in connection with a wooden post, and bell Fig. B, Plate 2411; Fig. D is a case designed for use with an iron pipe post, and bell Fig. C, Plate 2411.

Fig. B is a standard pinnacle for 3" pipe, to be used to complete the post arrangement when bell Fig. C, Plate 2411, is used with bell case Fig. D and bolted to the post at an intermediate point.

Fig. C is a relay box designed especially for use on the wooden post equipment.

Order by Plate and Figure

The drawing references are shown merely for convenience in checking material with shipping lists and invoices.

Fig.	Description	Drawing Reference	List Price
A	Case and Cover, with bolts, nuts and lag screw, for 12" bell Fig. B, Plate 2411.....	C-6145	11 00
B	Pinnacle for 3" pipe.....	9-B-8121	40
C	Relay Box for bell equipment (used on wooden post only).....	9-B-9636	16 00
D	Case and Cover, with lock, cap, bolts and nuts, for 10" bell Fig. C, Plate 2411.....	C-4809	5 00

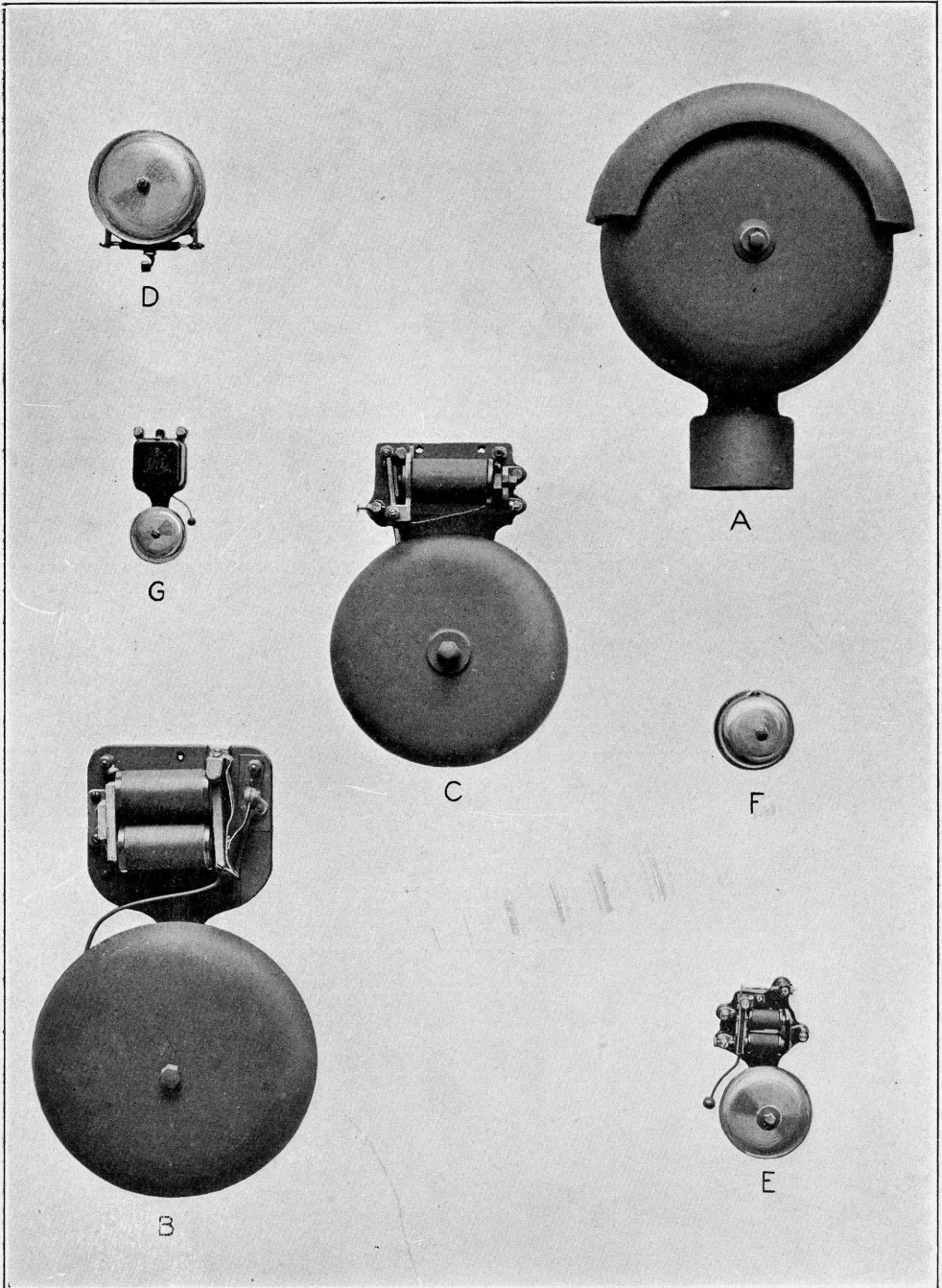

ELECTRIC BELLS—TYPICAL FORMS

ELECTRIC BELLS TYPICAL FORMS

The opposite plate illustrates a few typical forms of our bell stock. The larger 10-inch and 12-inch gongs are used with highway crossing protection equipment. The smaller 2-1/2-inch to 4-inch gongs are used mainly as annunciators to audibly call a signalman's attention to a visual indication.

For wooden bell boxes see Section 13, Plate 1308. For iron cases see Plate 2409. When ordering, specify resistance of magnets.

Order by Plate, Figure and Instructions given above

The drawing references are shown merely for convenience in checking material with shipping lists and invoices.

Fig.		Drawing Reference	List Price
A	D. C. Crossing Bell, with 12-inch gong and enclosed mechanism. (Used with iron pipe post).....	C-7376	44 50
B	D. C. Crossing Bell, with 12-inch gong and mechanism	B-94 N	25 00
Ba	D. C. Crossing Bell, with 12-inch gong, mechanism and case Fig. A, Plate 2409.....	C-6149	36 00
C	D. C. Crossing Bell, with 10-inch gong and mechanism	C-3634	25 00
Ca	As above with case Fig. D, Plate 2409.....		30 20
D	Single Stroke Electric Bell, with 5-inch nickel plated gong and mechanism.....	I-C-4257	15 30
Da	As above, with 4-1/2 inch nickel plated gong..	10-C-4257	13 80
E	Single Stroke Electric Bell, with 4-inch nickel plated gong and mechanism. (Standard Resistance)		3 50
F	Single Stroke Electric Bell, with 3-inch nickel plated gong and mechanism. (40 ohms resistance)....		6 00
G	Single Stroke Electric Bell, with 2-1/2 inch nickel plated gong and mechanism. (Standard Resistance)		3 50

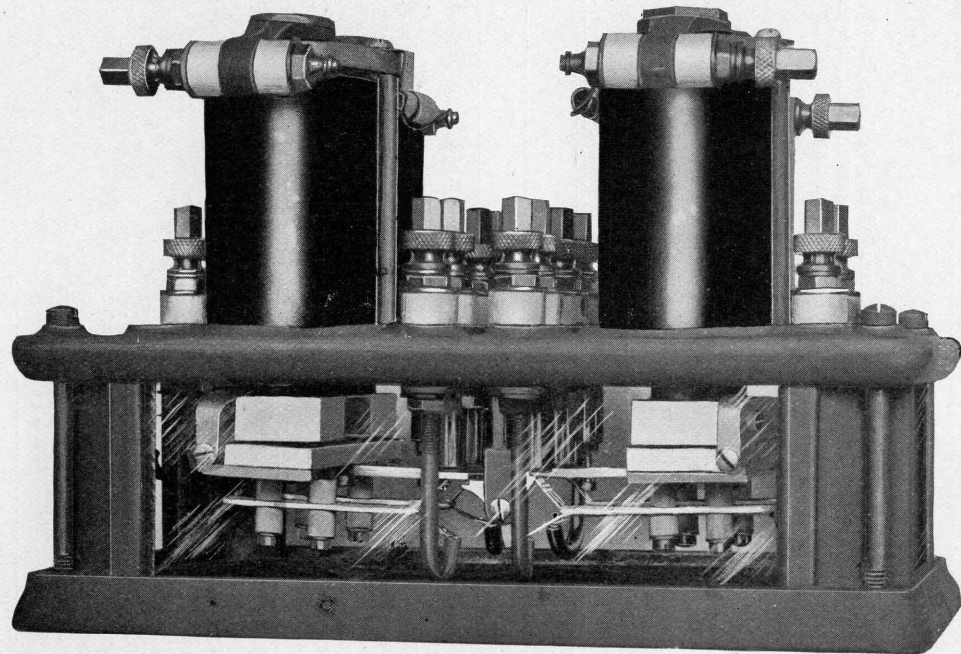

DIRECT CURRENT ENCLOSED UNIVERSAL INTERLOCKING
RELAY

DIRECT CURRENT ENCLOSED UNIVERSAL INTERLOCKING RELAY

For description and operation of the relay see pages 22 and 23.

Magnets are usually wound to 4 or 9 ohms resistance, which meet all average track conditions. When ordering specify resistance to which magnets are to be wound.

Order by Plate, Figure and Instructions given above

The drawing references are shown merely for convenience in checking material with shipping lists and invoices.

Fig.	Description	Drawing Reference	List Price
A	Four Point Direct Current Enclosed Universal Interlocking Relay—2 graphite front contacts for each pair of magnets.....	5-C-6507	74 00
B	Four Point Direct Current Enclosed Universal Interlocking Relay—2 silver back contacts for each pair of magnets.....	1-C-6507	74 00
C	Four Point Direct Current Enclosed Universal Interlocking Relay—2 graphite front contacts and 2 silver back contacts for each pair of magnets.	6-C-6507	80 00
D	Six Point Direct Current Enclosed Universal Interlocking Relay—2 graphite front contacts and one silver back contact for each pair of magnets...	3-C-6507	80 00
E	Eight Point Direct Current Enclosed Universal Interlocking Relay—4 graphite front contacts or 4 silver back contacts for each pair of magnets..	4-C-6507	90 00

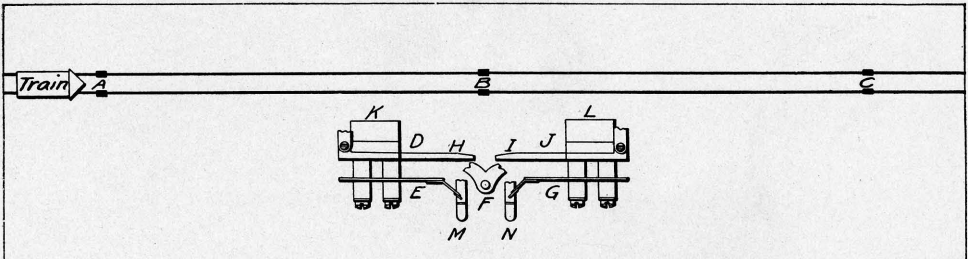

Fig. I

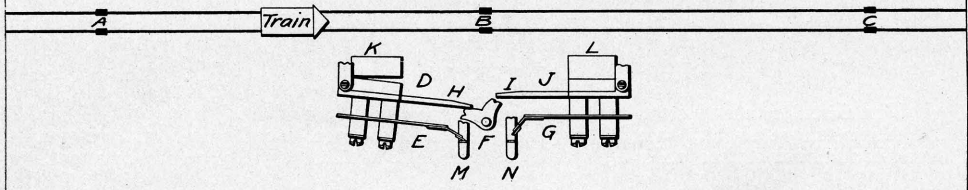

Fig. II

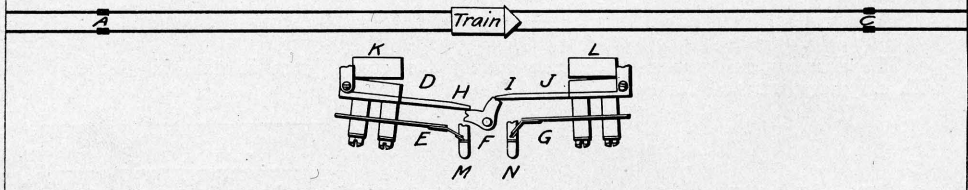

Fig. III

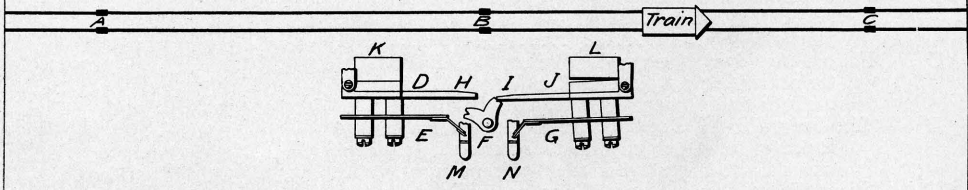
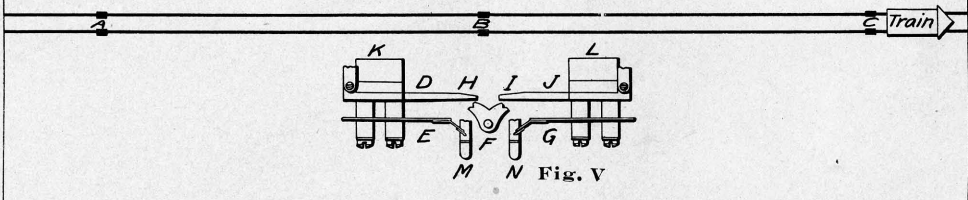

Fig. IV



M N Fig. V

DIAGRAMMATIC FIGURES TO ACCOMPANY DESCRIPTION OF THE OPERATION OF THE INTERLOCKING RELAY

THE OPERATION OF THE INTERLOCKING RELAY

Fig. 1 illustrates the normal condition of an interlocking relay when the coils are energized with the armatures "picked up" and the controlling track sections unoccupied. K and L are the magnet heads of the two electro-magnets of the relay; D and J are the armature bars that are hinged to K and L and carry the contact arms E and G, which are insulated from D and J. H and I represent the interlocking arms, carried by D and J, and engage the locking pawl F under certain conditions hereafter noted. M and N are graphite to platinum or platinum to platinum contacts connected to binding posts of the relay, to which external wires are fastened by thumb and jam nuts. A train is represented approaching the track section AB at A.

Fig. 2 illustrates the condition of the parts of the relay above noted after a train had entered the track section AB and is continuing on toward B.

The coils of magnet K are de-energized and the armature D has fallen away from the magnet head and made back contact with the post M. The interlocking arm H in falling throws locking pawl F to the position shown, thereby providing for the interference of this pawl and interlocking arm I, preparatory to the condition shown in Fig. 3.

Fig. 3 shows this condition as the train enters the section BC and short circuits the coils of L. The train at this instant will hold both relays open but the armature J cannot fall far enough to make back contact between N and G since the interlocking arm I has caught on the pawl F. This condition will remain until the train clears section AB as shown by Fig. 4.

Fig. 4. Here the train has passed out of section AB entirely, in consequence of which the armature D "picks up" and opens the contact between M and E, thereby breaking the local circuit passing through M and E. If it is a bell circuit, the bell will stop ringing. The armature J remains down and locked as heretofore shown.

As the train clears the section BC, the armature J. will raise and the relay will be in its normal condition as shown by Fig. 5.

A train movement from C towards A will operate the relay in a similar manner, but the closed local circuit will be through the contact NG, the interlocking arm H being locked by the pawl F.

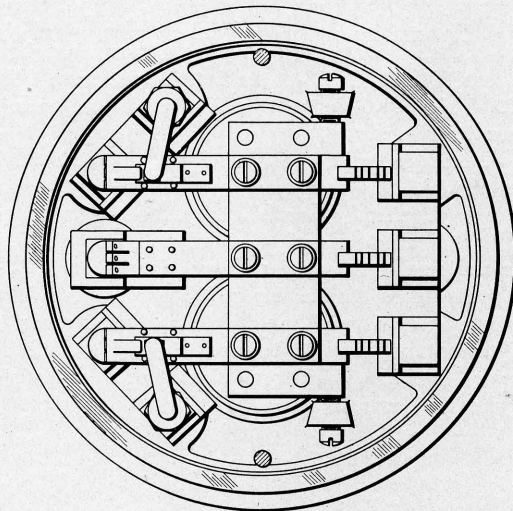
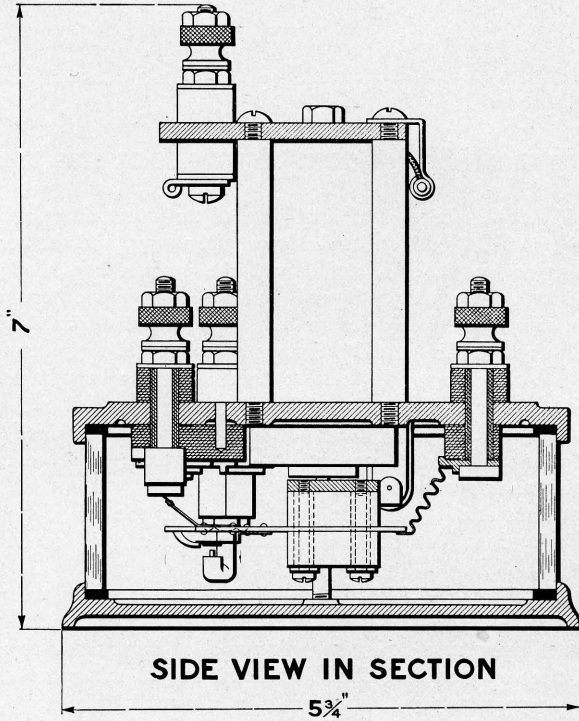

INVERTED PLAN VIEW
BOTTOM PLATE REMOVED

DIRECT CURRENT ENCLOSED 7-C RELAY

DIRECT CURRENT ENCLOSED 7-C RELAY

This relay is fitted throughout with high grade insulation and each relay must stand a test of 3500 alternating current volts before shipment.

The binding posts are prevented from turning by a new method recently introduced and all insulation blocks and bushings are of lignum vitae.

The back contacts are always of metal and unless otherwise specified graphite front contacts will be furnished.

When ordering specify resistance of magnets.

Order by Plate, Figure and Instructions given above

The drawing references are shown merely for convenience in checking material with shipping lists and invoices.

Fig.

- A D. C. Enclosed 7-C Relay—2 graphite front contacts and 2 silver back contacts.....
- B D. C. Enclosed 7-C Relay—3 graphite front contacts and 2 silver back contacts.....

Drawing Reference	List Price	
1-C-7214	28 90	
2-C-7214	32 24	

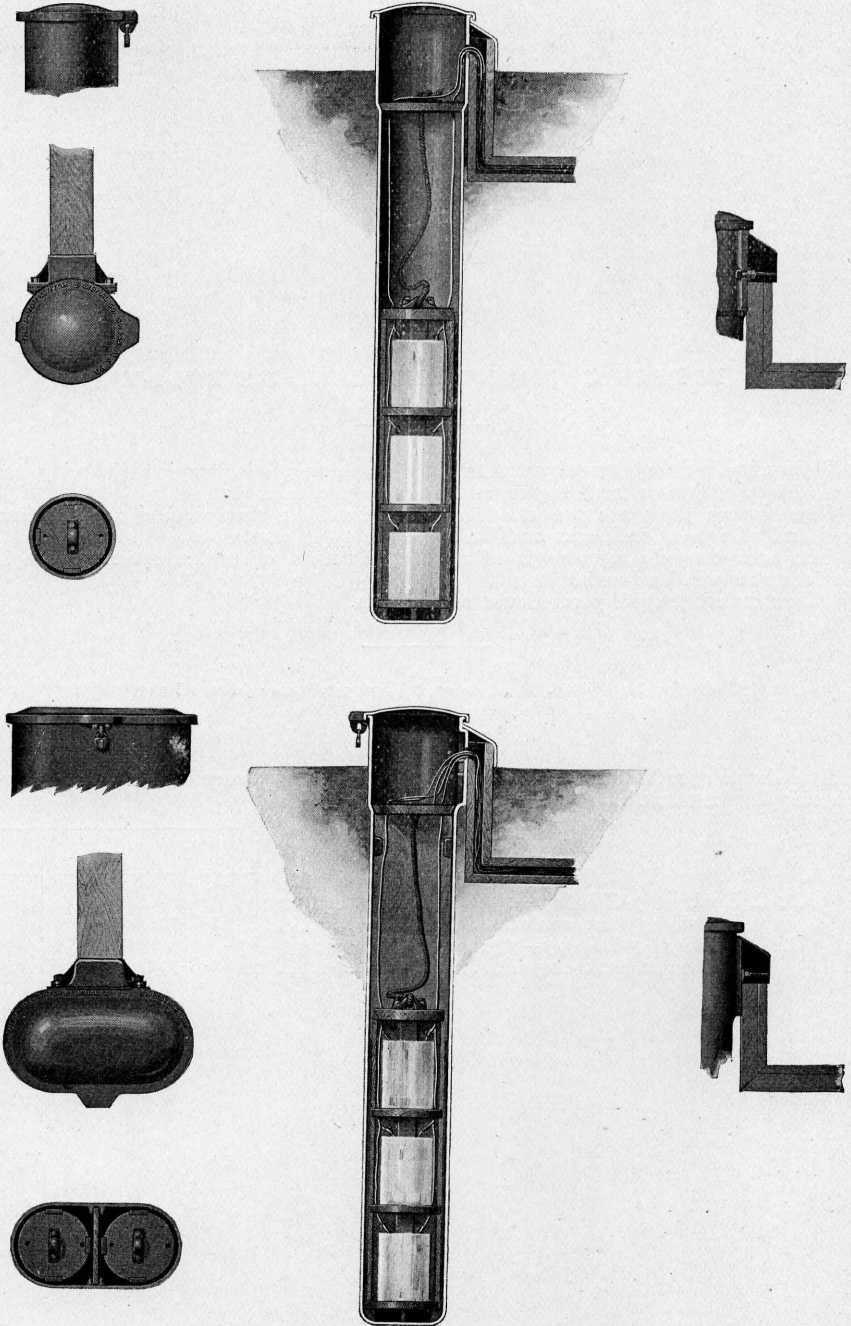

CAST IRON BATTERY CHUTES

CAST IRON BATTERY CHUTES

The opposite plate illustrates our latest design of single and double cast iron battery chutes. The economical distribution of the metal secures the maximum strength with minimum material. The sides are uniform in thickness and the bottom reinforced. A frost board is fitted to the chute about twelve inches from the top. Elevators may be had for two, three or four cells.

Order by Plate and Figure

The drawing references are shown merely for convenience in checking material with shipping lists and invoices.

Fig.		Drawing Reference	List Price
A	Single Cast Iron Battery Chute, 6'0", with trunking cap, frost board, two cell elevator and padlock. (No Batteries).....	1-C-6628	28 00
Aa	as above, with three cell elevator. (No Batteries)	"	28 35
Ab	as above, with four cell elevator. (No Batteries)	"	28 70
B	Single Cast Iron Battery Chute, 7'0", with trunking cap, frost board, two cell elevator and padlock. (No Batteries).....	2-C-6628	32 00
Ba	as above, with three cell elevator. (No Batteries)	"	32 35
Bb	as above, with four cell elevator. (No Batteries)	"	32 70
C	Single Cast Iron Battery Chute, 9'0", with trunking cap, frost board, two cell elevator and padlock. (No Batteries).....	3-C-6628	53 00
Ca	as above, with three cell elevator. (No Batteries)	"	53 35
Cb	as above, with four cell elevator. (No Batteries)	"	53 70
D	Double Cast Iron Battery Chute, 6'0", with trunking cap, frost board, two cell elevators and padlock. (No Batteries).....	7-C-6628	64 00
Da	as above, with two, three cell elevators. (No Batteries)	"	64 70
Db	as above, with two, four cell elevators. (No Batteries)	"	65 40
E	Double Cast Iron Battery Chute, 7'0", with trunking cap, frost board, two, two cell elevators and padlock. (No Batteries).....	8-C-6628	68 90
Ea	as above, with two, three cell elevators. (No Batteries)	"	69 70
Eb	as above, with two, four cell elevators. (No Batteries)	"	70 40
F	Double Cast Iron Battery Chute, 9'0", with trunking cap, frost board, two, two cell elevators and padlock. (No Batteries).....	9-C-6628	78 30
Fa	as above, with two, three cell elevators. (No Batteries)	"	79 00
Fb	as above, with two, four cell elevators. (No Batteries)	"	79 70

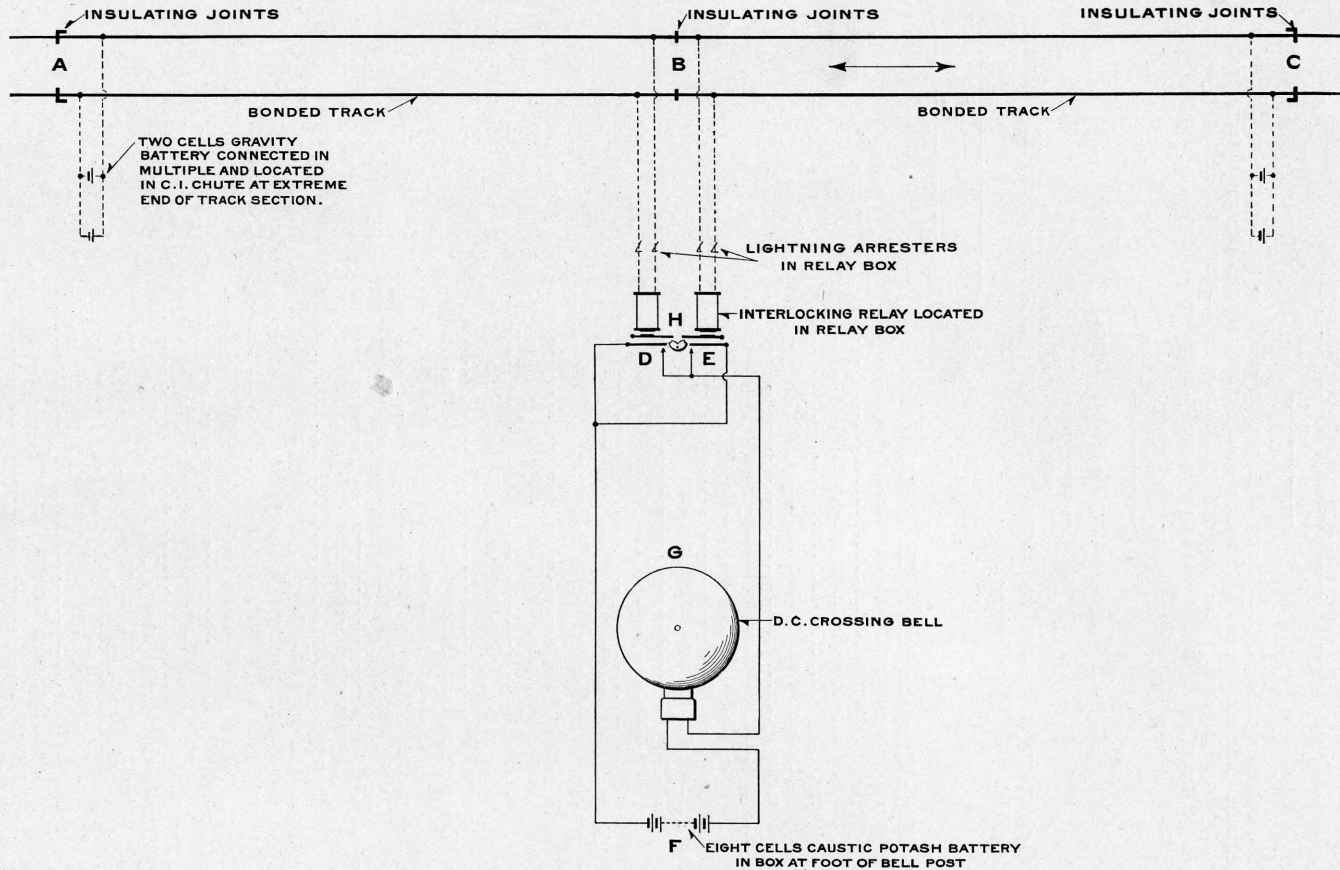

25

Fig. 1

SINGLE TRACK DIRECT CURRENT CROSSING BELL LAYOUT.

SINGLE TRACK DIRECT CURRENT CROSSING BELL LAYOUT

The ordinary D. C. Bell installation for single track grade crossing at a street or highway is shown by Fig. 1.

A bonded section of track, 1,500 feet to one-half mile or more, is used on each side of the highway in the direction of train movements. Insulations are used at the end of these sections as shown at A, B and C. As a train enters from either end the interlocking relay makes back contact on one or the other fingers attached to the armatures of coils D or E which completes the local bell circuit of battery F. As it is desired to stop the bell as soon as a train has cleared the crossing after entering the ringing section, a means must be provided to prevent the armature of the coils of that part of the relay controlled from the section beyond the crossing, from dropping far enough to make back contact when a train passes the crossing. The locking pawl H provides for this emergency. Thus, the bell will ring from the time a train enters the section until it passes over the crossing.

The following list of material is necessary for Single Track Crossing Bell Equipment; Starting Sections 1500 ft.

QUANTITY

1	Combined Bell, Bell Post, Sign, Relay Box and Battery Box. See Fig. A, Plate 2403.....
1	Universal D. C. Enclosed Interlocking Relay. See Fig. A, Plate 2413.....
2	Single Cast Iron Battery Chutes. See Fig. Cb, Plate 2417
8	Cells Edison Primary Battery, type R. R.....
4	Cells Gravity Battery.....
4	One-Way Lightning Arresters. (Specify type).....
150	Lin. Ft. Yellow Pine Trunking. See Fig. A, Plate 2435
30	Ft. No. 9 Flexible Copper Wire.....
50	Ft. No. 14 Insulated Soft Drawn Copper Wire, with 7/32" rubber wall, 1 braid and O tape.....
250	Ft. No. 9 Insulated Soft Drawn Copper Wire, with 9/32" rubber wall, 1 braid and O tape.....
10	Ft. No. 16 Electric Light Cord.....
400	Bond Wires No. 8, E. B. B. Galvanized Iron (Specify length). See Fig. 2, Plate 2429.....
800	Channel Pins for bond wires (No percentage allowed to cover waste or loss). See Fig. 1a, Plate 2429.
1	Lb. Solder (Wire).....
1	4-oz. Bottle of Soldering Compound.....
1/2	Lb. 3/4" Manson Cloth Tape.....
1/2	Lb. 3/4" Okonite Rubber Tape.....
2	Lbs. 8d Wire Nails.....
4	Keystone Insulated Rail Joints. See Plate 2425.....

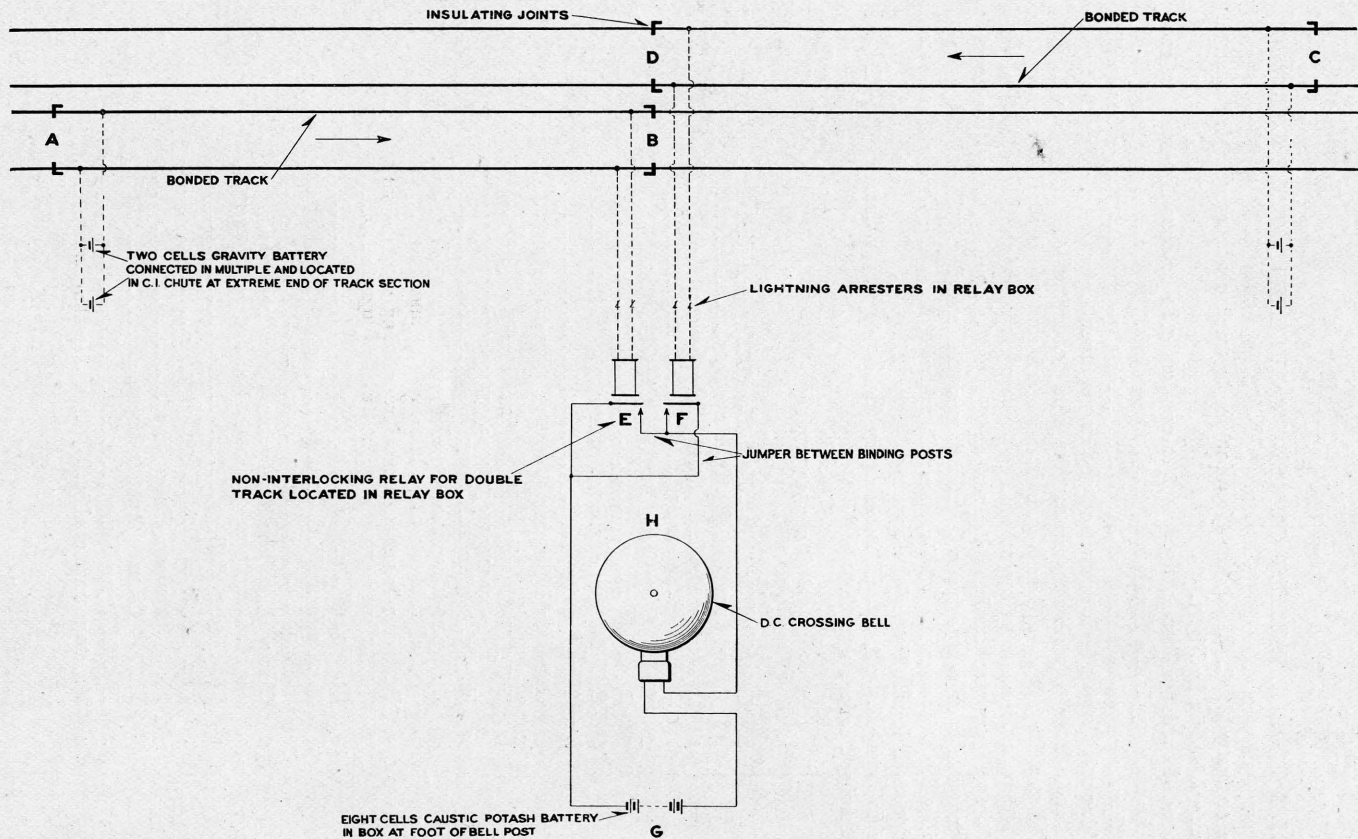

Fig. 2

DOUBLE TRACK DIRECT CURRENT CROSSING BELL LAYOUT

DOUBLE TRACK DIRECT CURRENT CROSSING BELL LAYOUT

The ordinary bell installation for double track grade crossing at a street or highway is shown by Fig. 2.

A bonded section of track, 1,500 feet to one-half mile or more, is used on each side of the highway in the direction of train movements. Insulations are used at the end of these sections as shown at A, B, C and D.

An interlocking relay (with the locking pawl removed) is used to control the local bell circuit. Two ordinary Model 7-C relays would answer as well but it is often desirable to maintain the interlocking type as a standard for bell work, besides it is more economical of space.

A train entering the ringing sections at A or C will short circuit the coils E or F respectively and drop an armature. These armatures carry contact springs that close a local bell circuit on a back contact so that the bell H will ring as long as the circuit of battery G is closed, i. e., until the armatures of E and F are "picked up," which is equivalent to a train clearing the sections A to B or C to D.

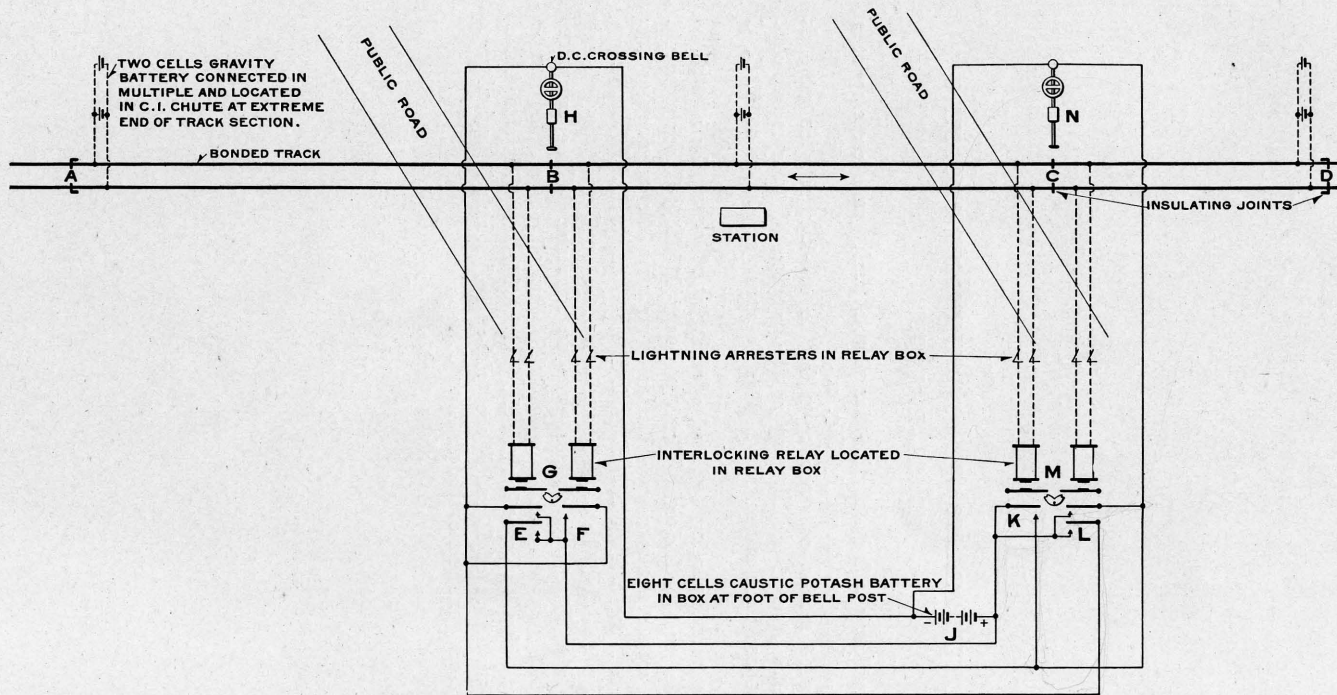

Fig. 3

SPECIAL DIRECT CURRENT CROSSING BELL LAYOUTS OF TWO OR MORE BELLS IN SEQUENCE

SPECIAL DIRECT CURRENT CROSSING BELL LAYOUT OF TWO OR MORE BELLS IN SEQUENCE

In localities where two or more bells are installed, it is sometimes necessary to introduce special wiring in order to provide suitable warning distances for each bell.

In Fig. 3 two bells are shown at adjacent crossings. The points at which each bell will start to ring should depend largely upon the distance between the two highways. If, in the cut on the opposite page, this distance were approximately 600 feet, a train approaching at A or D should start both bells simultaneously and cut each out as it is passed. Should the distance between the highways be nearly 1,200 feet, a train approaching at D, for instance, would start bell N ringing. When the same train reaches C the bell H would ring, each cutting out as its respective crossing is passed.

Another scheme sometimes employed where H and N are a very short distance apart is to place track insulations at a point half-way between H and N, when both bells would cease to ring when a train had passed a point midway between them.

There are many instances where from four to ten or more bells are installed consecutively for the complete protection of village streets, in which case it becomes necessary to ring two, three or perhaps four bells in advance of an approaching train, each being cut out as the train passes.

All such layouts may be satisfactorily protected.

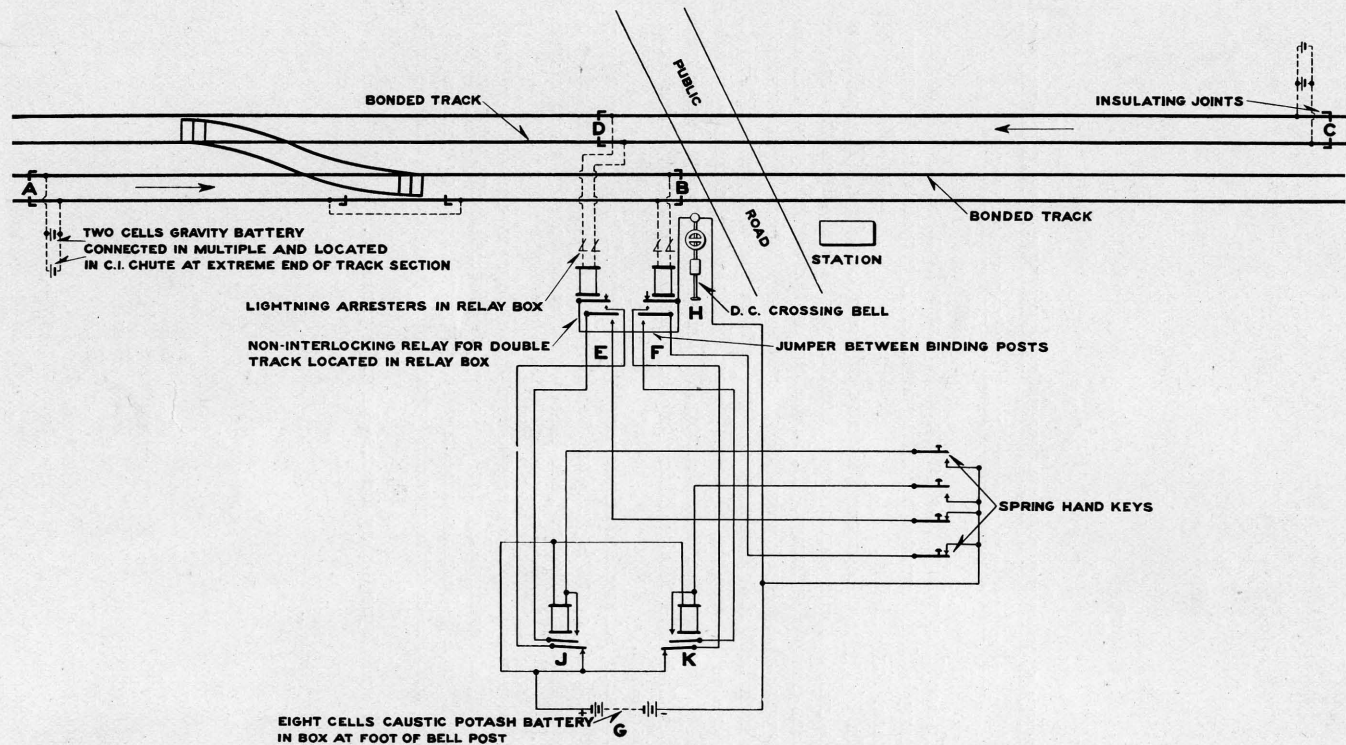

Fig. 4

SPECIAL DIRECT CURRENT CROSSING BELL LAYOUTS

SPECIAL DIRECT CURRENT CROSSING BELL LAYOUT

Fig. 4 will serve to illustrate a number of special conditions under which it is advisable to use special keys in addition to the standard layout in order to stop and start a crossing bell in connection with certain train movements as a means of preventing false alarms and continuous ringing.

The additional material required will be two relays, J and K, at the crossing, and four spring hand keys mounted on hard rubber bases located so that they will be convenient to trainmen or operators.

The momentary closing of either key contact cuts the bell out or in, it not being necessary to retain the finger on the key for more than an instant.

In connection with this feature it should be understood that only when a train is on the track section approaching the crossing can the bell be manually cut out. It may again be cut in, when it will ring until the train passes over the highway; or should the operator neglect to cut the bell in, the train will automatically perform this operation in passing out of the bonded sections, and restore the instruments to their normal positions so that the bell will again ring for the next approaching train.

The following examples will illustrate a few of the conditions met in actual practice and will give an idea of the many instances where a highway crossing bell can be used successfully and to advantage at points where the track layout or switching conditions are somewhat complicated:

Case 1. If an approaching train enters the bonded section at A and stops at the Station, the bell H at highway would ordinarily ring during the time that stop is made and until train again proceeds and passes beyond the crossing. In consequence, the bell is ringing during the time that train is at a stop and the street is open to the safe passage of the public. If such a condition is allowed to continue, the bell ceases to become a warning and is locally classed as a public nuisance.

A stop and start key is installed in the depot. Under these conditions the agent presses the stop key when train slows down and the bell consequently ceases to ring. If the crossing is very close to the station no starting key is required, for the train may proceed slowly over the crossing with the engine bell ringing, and in passing beyond the bonded sections will automatically restore the instruments, as before stated.

Should the crossing be some distance from the station, however, the agent may press a starting key when the train is ready to proceed, and

give the proper warning at the highway. In this latter instance, of course, the bell will stop ringing when the entire train has passed over the crossing.

Case 2. Referring to the same layout, should the station be a day station only, or for any reason should it be undesirable for the agent to handle operating keys, the same results may be obtained as outlined in Case 1, by inserting short one-rail sections in the track circuit approaching the crossing in lieu of the keys, and thereby make the cut-in and cut-out feature dependent entirely on the location of the engine relative to the crossing or a train in coming to a stop at station passes onto a stop section and automatically cuts the bell out of circuit. When the same train again proceeds, the engine enters a starting section located at a specified distance from the crossing and bell again rings, it being understood that the stop and start sections are such a short distance apart that a through train approaching the crossing at speed will give practically a continuous warning, as its effect in passing over the cut-out and cut-in section will cause no noticeable interruption to the bell circuit.

Case 3. Should the approach section to a bell include a switch, as shown in Fig. 4, it is advisable to provide a stop and a start key at such a switching point for the convenience of trainmen in controlling the ringing of the bell while switch is being used and cars are being "kicked" on and off the bonded section. The keys are usually placed in a suitable box shelter and mounted upon a post adjacent to the switchstand. Keys at the switch and station, or at a number of different points, may be used to control the same bell without in any way conflicting with its operation.

ALTERNATING CURRENT CROSSING BELLS

The features peculiar to A. C. Crossing Bells are chiefly as follows:

When no current is in the track rails, other than that used to operate direct current crossing bells, the problem is much simpler than when the rails bear current foreign to the bell system, such as earth currents or that for train propulsion purposes. In either case, the use of alternating current of a proper frequency for controlling the bell provides the necessary selective feature in that the track relay responds to its own current and to no other. The circuits shown in layouts, pages 46 and 48, apply to steam roads where foreign current prevents the use of battery track circuits and to direct current propulsion electric roads on which the single rail return system is applicable. In cases where the double rail return of propulsion power current is desired, it is necessary to use balanced reactance bonds at the ends of the track circuits. In such cases the track transformer has characteristics differing from the track transformer used with the single rail scheme.

The capacity of the reactance bond is determined by the maximum and average amount of propulsion return current and all of the track circuit apparatus is affected by the conditions existing at the locality under consideration. For these reasons we are unable to give complete information which will apply to all cases and would ask that prospective customers write us fully as to their conditions, upon receipt of which we will be glad to furnish a scheme with estimate.

In addition to the information required for making proposals for D. C. crossing bell installation (see page 4), the following information should be furnished:

FIRST. The voltage and frequency of the alternating current available and the maximum fluctuation of the voltage.

SECOND. The maximum and average amount of propulsion return current at the locality under consideration.

THIRD. Whether the propulsion current is direct or alternating, and if the latter, state its frequency.

FOURTH. Whether one rail of each track may be used for track circuit purposes, leaving the other rail only for propulsion return current purposes.

FIFTH. The length of the track circuits, character of ballast and whether the rail is in contact with such ballast.

SIXTH. Weight, section and drilling of the rail; and any other features peculiar to the proposed installation.

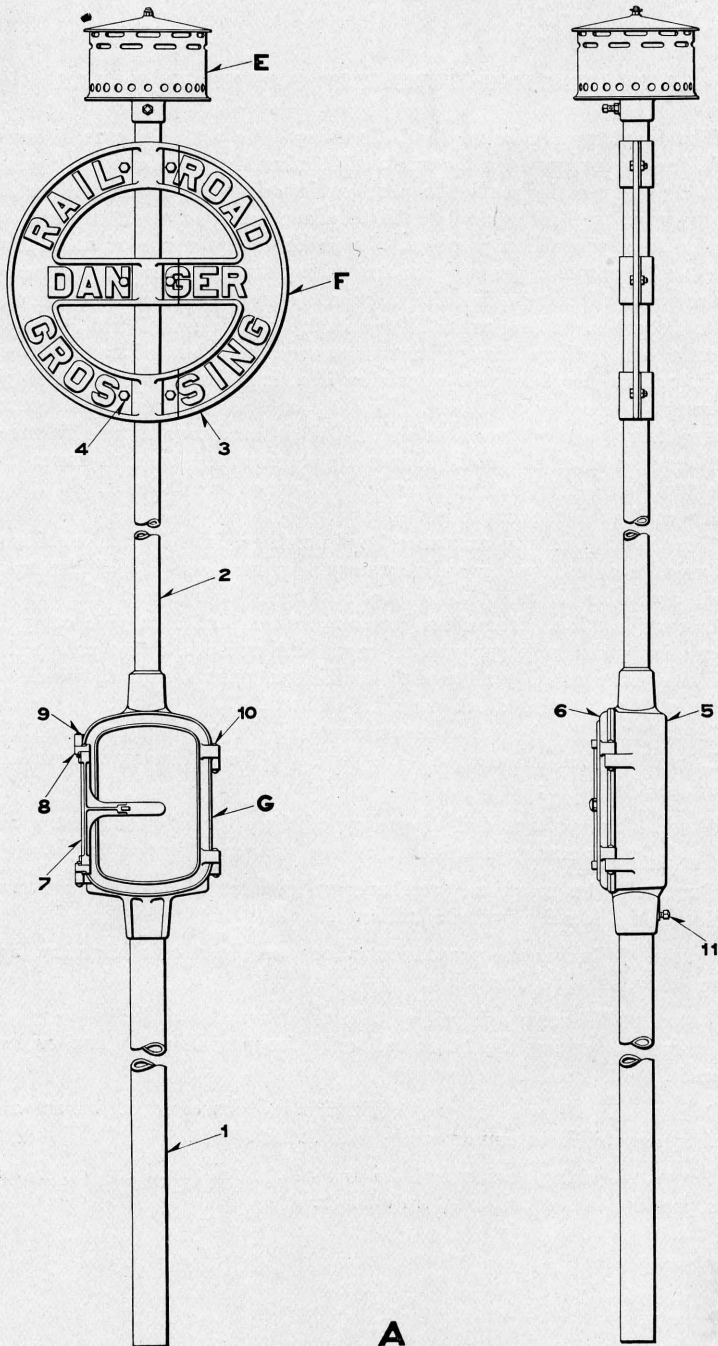

A

THE UNION ELECTRIC ALTERNATING CURRENT
CROSSING BELL
(MOUNTED ON IRON PIPE POST)

**THE UNION ELECTRIC ALTERNATING CURRENT
CROSSING BELL
(MOUNTED ON IRON PIPE POST)**

For detail of bell see Plate 2421.

The coils are usually wound to 60 cycles—45 volts, and 25 cycles—55 volts. When ordering specify frequency and voltage.

Order by Plate and Figure

The drawing references are shown merely for convenience in checking material with shipping lists and invoices.

Fig.	Drawing Reference	List Price
A	Combined Bell, Bell Post, Sign and Relay Box, as shown	3-B-8912 121 00
B	Combined Bell, Bell Post and Relay Box. (No sign)	" 110 00
C	Combined Bell, Bell Post and Sign. (No relay box)	" 101 60
D	Combined Bell and Bell Post. (No sign or relay box)	" 90 00
E	A. C. Crossing Bell. See Plate 2421	73 00
F	Sign, with bolts and nuts, (1-3, 6-4)	C-5844 11 00
G	Relay Box with wood lining, shelves and lock. (No relay or lightning arresters), (1-5, 1-6, 1-7, 2-8, 2-9, 2-10, 1-11)	1-B-9636 25 50
1	Lower Post, 4" casing	13-B-9893 5 90
2	Upper Post, 3" casing	117-B-5161 4 40
3	Half of Sign. Specify which half is required	C-5844 5 50
4	Hex. Hd. Bolt and Nut, $\frac{5}{8}$ "x $2\frac{3}{4}$ ", for fastening sign Fig. 3 to post Fig. 2	08
5	Relay Box only	6-D-783 13 50
5a	as above, with rubber gasket	14 90
6	Door, with staple only	1-D-783 3 90
7	Hasp	4-B-8299 46
8	Link for hasp Fig. 7	7-D-783 16
9	Special Pin for fastening link Fig. 8 to relay box Fig. 5	46-B-8058 06
10	Rd. Hd. Iron Rivet, $\frac{3}{8}$ "x $3\frac{1}{4}$ ", for fastening door Fig. 6 to relay box Fig. 5	02
11	Sq. Hd. Steel Set Screw, $\frac{5}{8}$ "x1", for relay box Fig. 5	04

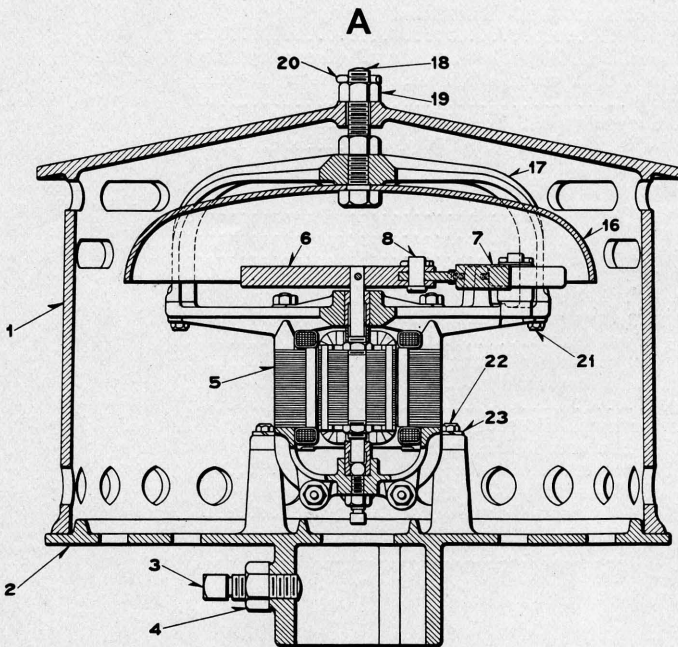
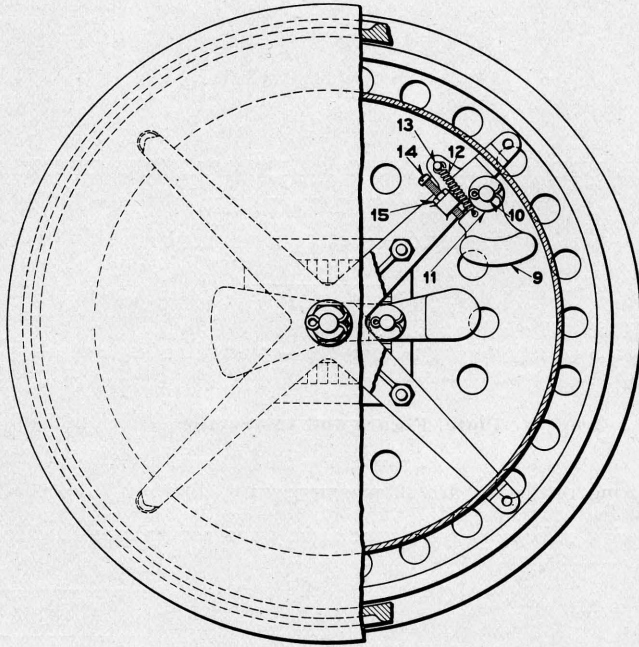

THE UNION ELECTRIC ALTERNATING CURRENT
CROSSING BELL

**THE UNION ELECTRIC ALTERNATING CURRENT
CROSSING BELL**

The gong of the A. C. Crossing Bell is the same as that used on the D. C. Crossing Bell. The tapper which strikes the gong receives its motion from another tapper, carried by and pivoted to the outer end of an arm, the center of which arm is connected to the armature shaft of an induction motor. This induction motor, being of the squirrel cage type, is without commutator or circuit controlling device. The bell and its mechanism are provided with substantial cast iron housing to protect them from injury, while perforations in the housing permit the sound to escape with but little interference.

The coils are usually wound to operate on 60 cycles at 110 volts, and on 25 cycles at 55 volts. When ordering specify frequency and voltage.

For application of bell see Plate 2419.

Order by Plate, Figure and Instructions given above

The drawing references are shown merely for convenience in checking material with shipping lists and invoices.

Fig.		Drawing Reference	List Price
A	A. C. Crossing Bell, as shown.....	D-1295	73 00
1	Cover	14-C-7357	4 70
2	Base	15-C-7357	4 30
3	Steel Set Screw, 5/8"x1-7/8".....		05
4	Nut, 5/8".....		03
5	Laminated Field, with coils, upper and lower bearing support, armature, bushings, terminal posts, studs, set screw and nuts.....	D-1295	43 00
6	Operating Arm, with steel pin.....	18-C-7357	2 40
7	Striking Arm	12-C-7357	2 00
8	Pin, with cotter, for fastening striking arm Fig. 7 to operating arm Fig. 6.....	10-B-10208	10
9	Clapper	11-C-7357	80
10	Stud, with cotter.....	130-B-8114	12
11	Washer	3-B-7824	01
12	Spring	71-B-8124	30
13	Stud for spring Fig. 12.....	131-B-8114	10
14	Special Screw, No. 10-32x1-1/4", for adjusting clapper Fig. 9.....	317-B-8098	12
14a	as above, with nut, (1-14, 1-15).....	"	16
15	Nut for screw Fig. 14.....	49-B-8265	04
16	Gong, 12".....	7-B-8379	3 80
17	Gong Support.....	3-C-7357	2 50
18	Special Bolt, 1/2"x3-1/8", for supporting gong Fig. 16 and for securing cover Fig. 1.....	30-B-8280	30
19	Nut, 1/2", for special bolt Fig. 16.....		03
20	Steel Cotter, 3/16"x1", for special bolt Fig. 18.....		01
21	Hex. Hd. S. Tap Bolt, 1/4"x3/4", for fastening gong support Fig. 17 to upper bearing support for laminated field Fig. 5.....		02
22	Hex. Hd. S. Tap Bolt, 1/4"x7/8", for fastening lower bearing support of laminated field Fig. 5 to base Fig. 2.....		02
23	Lock Washer, 1/4".....	13-B-7926	07

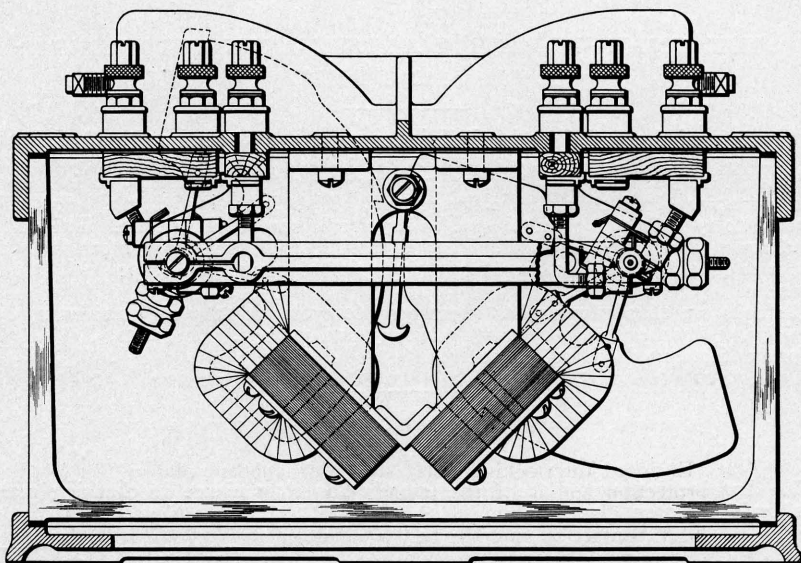

SECTIONAL SIDE VIEW

A

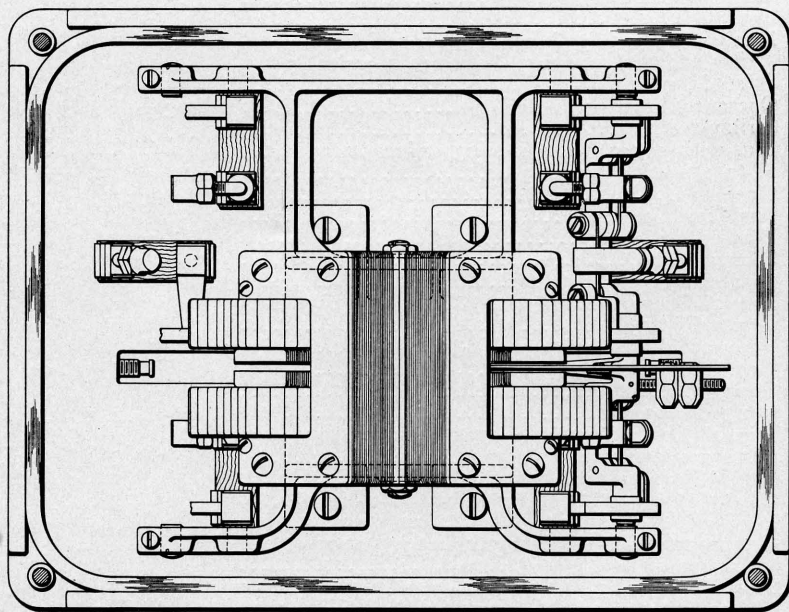

INVERTED PLAN VIEW

ALTERNATING CURRENT ENCLOSED INTERLOCKING RELAY

ALTERNATING CURRENT ENCLOSED INTERLOCKING RELAY

The A. C. Enclosed Interlocking Relay shown on opposite plate is for single track crossing bell protection and is of the induction type in which an aluminum vane is the moving element. The case contains the parts of two independent relays, each relay operating one back contact to ring the bell when de-energized by a train on the track circuit to which it is connected, and two front contacts to control signal or other circuits. The outer edge on the vane of each relay is cut in the form of a motion plate to operate the interlocking part which is common to the vanes of both relays. The principles involved and the results accomplished are identical with those of the well known direct current apparatus.

When ordering specify frequency and voltage.

Order by Plate, Figure and Instructions given above

The drawing references are shown merely for convenience in checking material with shipping lists and invoices.

Fig.

A A. C. Enclosed Interlocking Relay, with wire wound coils and one back and two front silver contacts.

Drawing Reference	List Price	
13-C-4194	150 00	

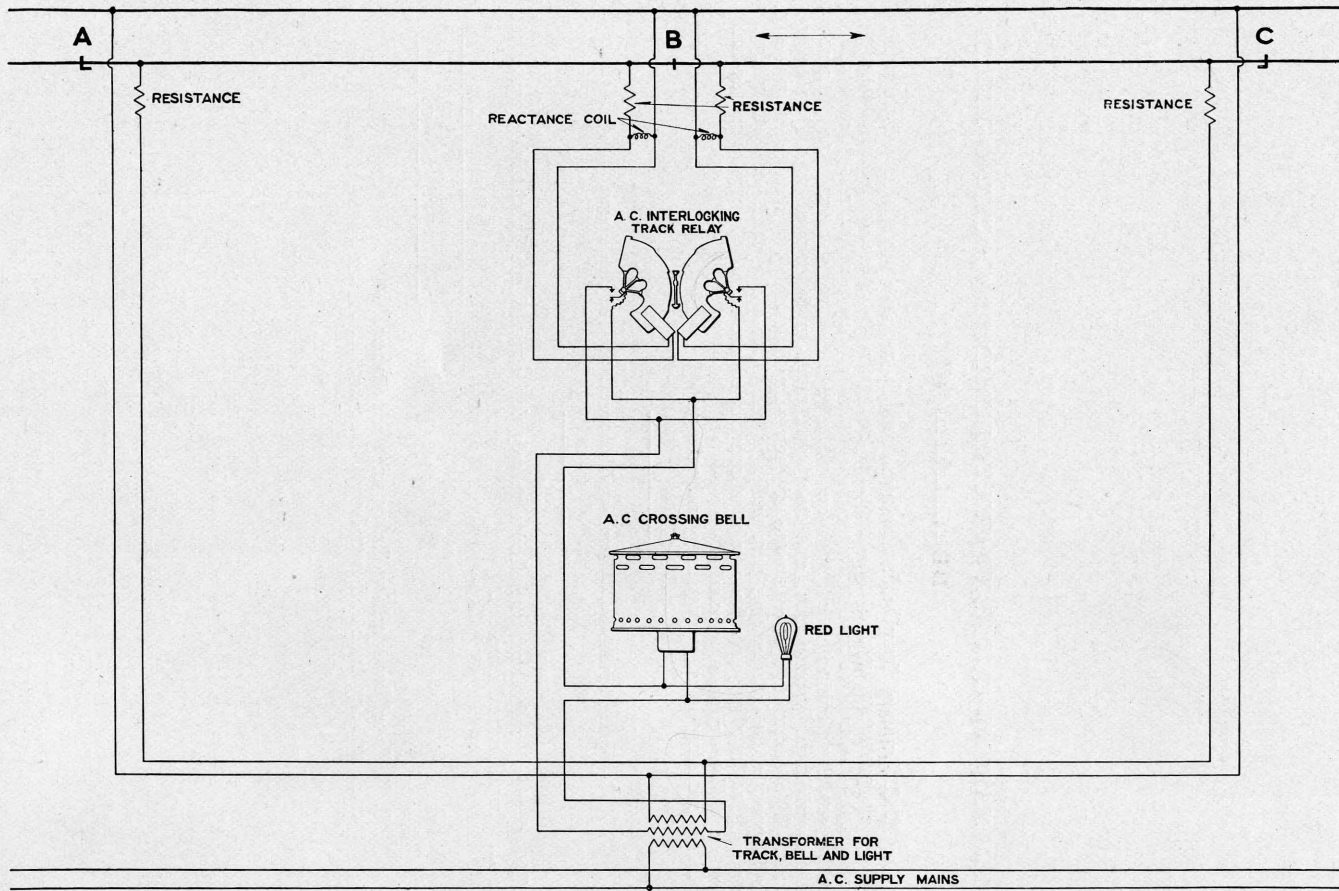

44

Fig. 5

SINGLE TRACK ALTERNATING CURRENT CROSSING BELL LAYOUT

SINGLE TRACK ALTERNATING CURRENT CROSSING BELL LAYOUT

The ordinary A. C. bell installation for single track grade crossing at a street or highway is shown by Fig. 5.

As in the D. C. installation a bonded section of track, 1,500 feet to one-half mile or more, is used on each side of the highway crossing.

Insulations are placed in one rail only at the ends of the section, as shown at A, B and C; the other rail serving as a return.

An interlocking relay of the type shown on Plate 2423 is used to control the bell circuit. The current is supplied from the A. C. mains, through a transformer, and fed into each section at the end at which the train enters the section and from the track through resistance and reactance coils, to the relay at the opposite end.

A train entering the ringing sections AB or CB will shunt the track section and cut off the current to the relay, causing the vane to drop and in so doing close the bell circuit through a back contact and cause the bell to ring so long as the section is occupied.

The interlocking features are identical with those employed on the D. C. relay and illustrated on Plate 2413.

The reactance coils shown in the layout may be omitted on railroads using steam as motive power.

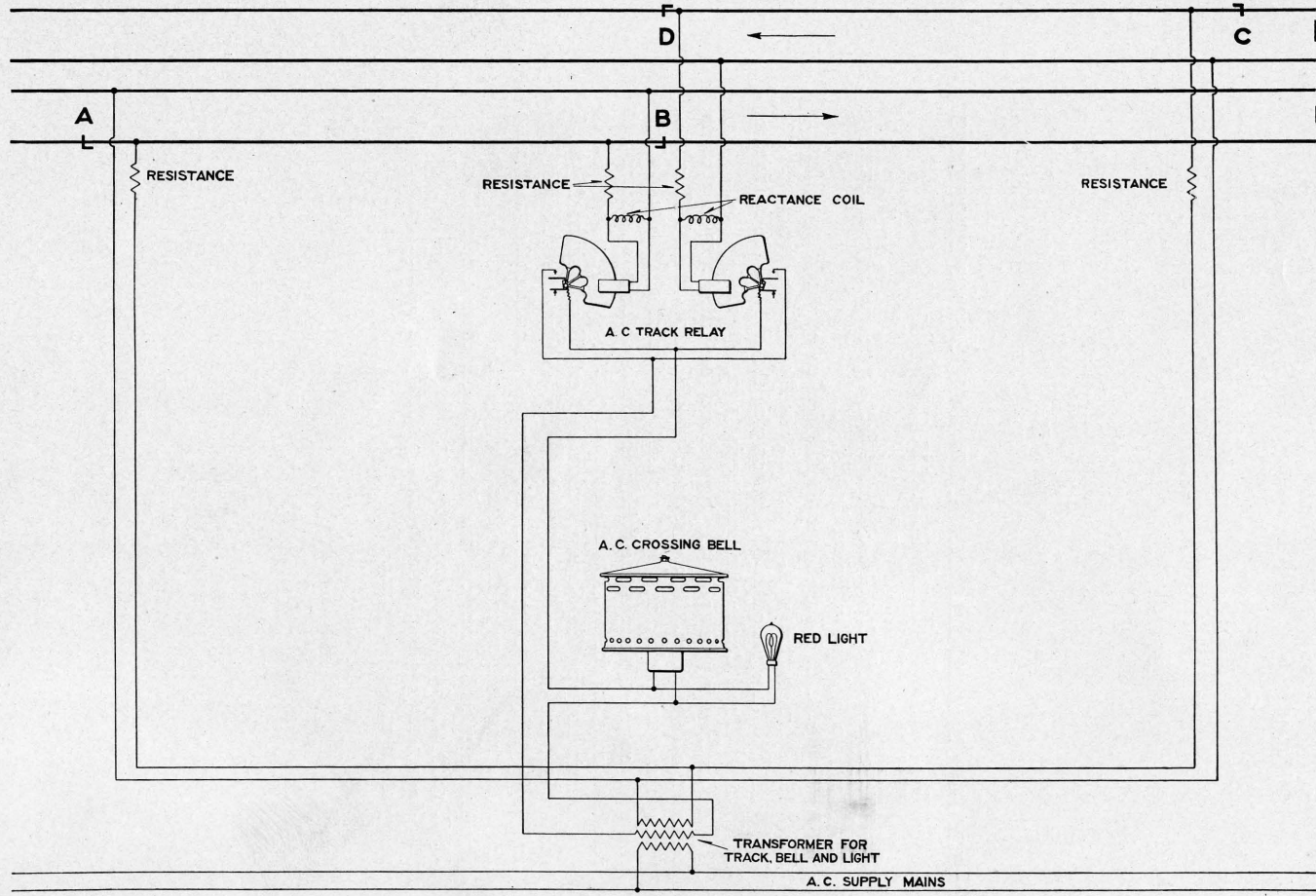

Fig. 6
DOUBLE TRACK ALTERNATING CURRENT CROSSING BELL LAYOUT

DOUBLE TRACK ALTERNATING CURRENT CROSSING BELL LAYOUT

The ordinary A. C. bell installation for double track grade crossing at a street or highway is shown by Fig. 6.

A bonded section of track is used on each side of the highway crossing, as described in Fig. 4. Insulations are used at the ends of these sections as shown—A to B and C to D.

Two ordinary vane type A. C. relays are used to control the bell circuit.

A train entering the ringing sections AB or CD will shunt the track section and cut off the current to the relay, causing the vane to drop and in so doing close the bell circuit through a back contact and cause the bell to ring so long as the section is occupied.

The reactance coils shown in the layout may be omitted on railroads using steam as motive power.

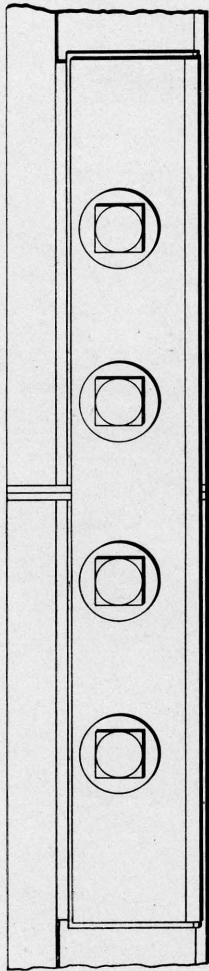
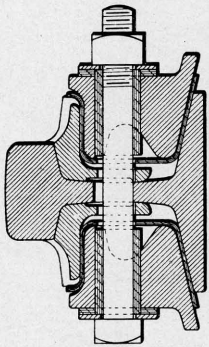

A

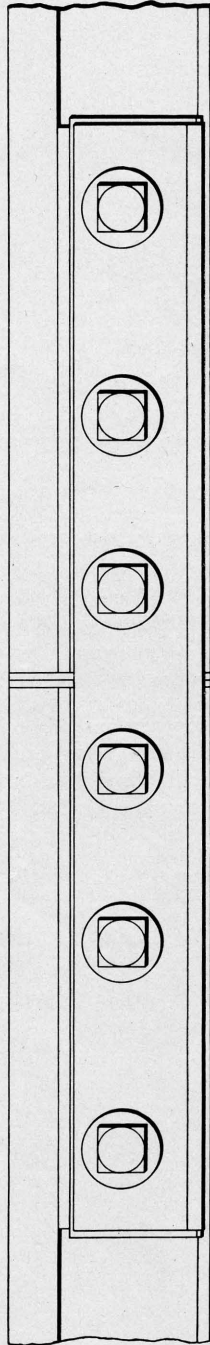

B

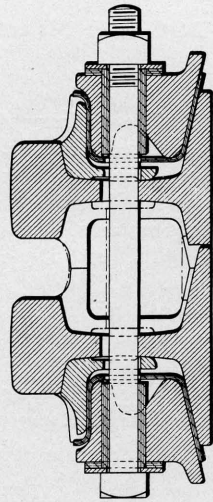

C

KEYSTONE INSULATED RAIL JOINTS

KEYSTONE INSULATED RAIL JOINTS

There is no part of a track circuit equipment that deserves more careful consideration than the insulated joint, in order that the track may maintain its surface and alignment, that the joint be of neat appearance, compact and easily applied, that maintenance and renewals be readily accomplished and that current leakage be a minimum.

The prices quoted below are for A. S. C. E. rails. Prices for other sections will be furnished on application.

The filler between rails is not furnished as part of the guard rail joint.

Fig. "A" shows a 4-hole insulated joint.

Fig. "B" shows a 6-hole insulated joint.

Fig. "C" shows sectional view of joint for guard rail.

When ordering a sketch should accompany the order giving distances from center to center of bolt holes and from base of rail to centre of bolt holes; also specify the maker's name, weight of rail and whether a 4 or 6 hole joint is required.

For details see Plate 2427.

Order by Plate, Figure and Instructions given above

The drawing references are shown merely for convenience in checking material with shipping lists and invoices.

Fig.	Description	Drawing Reference	List Price
A	Keystone insulated Rail Joint, 4-hole, for 75 lb. to 85 lb. rail.....	C-744I	13 35
Aa	Keystone Insulated Rail Joint, 4-hole, for 90 lb. to 100 lb. rail.....		
B	Keystone Insulated Rail Joint, 6-hole, for 75 lb. to 85 lb. rail.....	"	14 50
Ba	Keystone Insulated Rail Joint, 6-hole, for 90 lb. to 100 lb. rail.....	"	16 60
C	Keystone Insulated Rail Joint, 4-hole, for guard rail, for 75 lb. to 85 lb. rail.....	"	18 10
Ca	Keystone Insulated Rail Joint, 4-hole, for guard rail, for 90 lb. to 100 lb. rail.....		14 45
D	Keystone Insulated Rail Joint, 6-hole, for guard rail, for 75 lb. to 85 lb. rail.....		15 60
Da	Keystone Insulated Rail Joint, 6-hole, for guard rail, 90 lb. to 100 lb. rail.....		18 10
			19 60

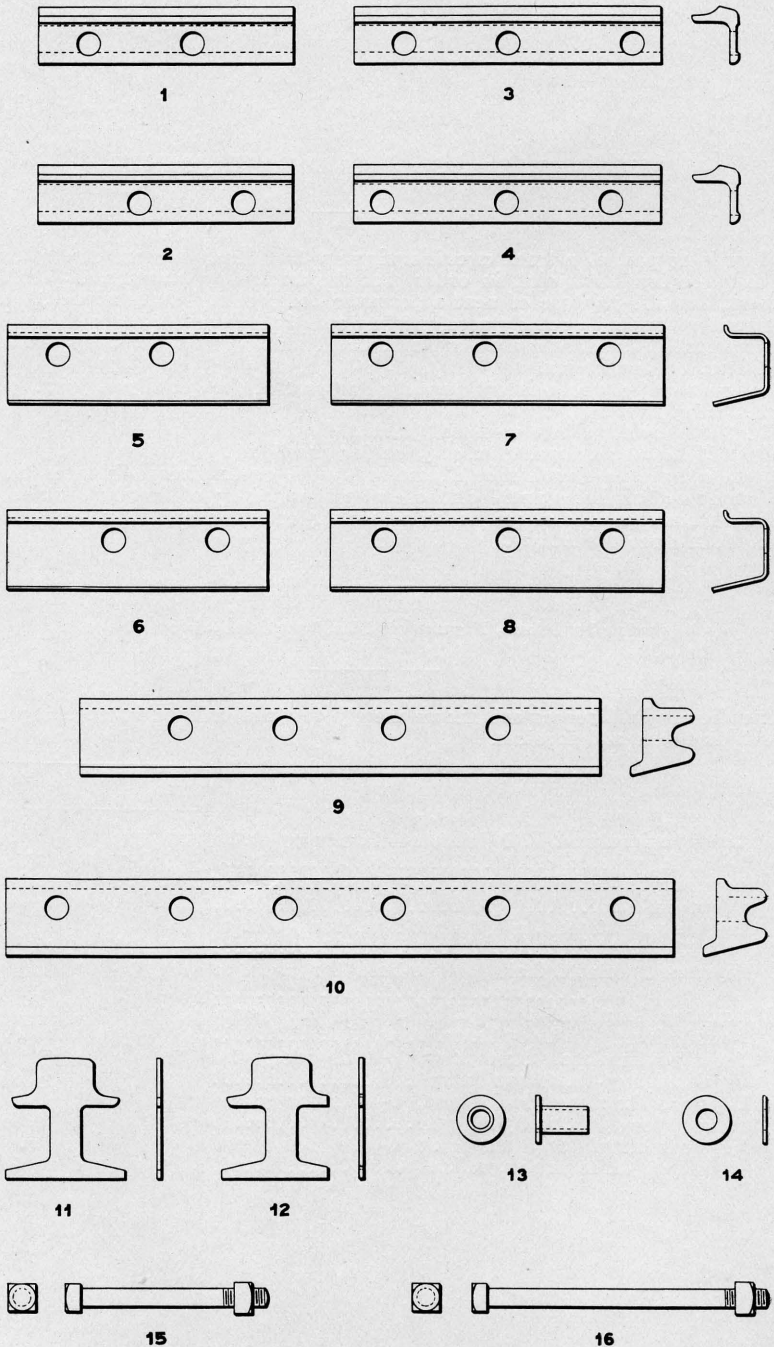

DETAILS OF KEYSTONE INSULATED RAIL JOINT

DETAILS OF KEYSTONE INSULATED RAIL JOINT

The prices quoted below are for parts for A. S. C. E. rails. Prices for parts for other sections will be furnished on application.
 For general drawing of Keystone Insulated Rail Joint see Plate 2425.

Order by Plate and Figure

The drawing references are shown merely for convenience in checking material with shipping lists and invoices.

Fig.		Drawing Reference	List Price
1	Right Hand Steel Filler, for 4-hole joint, for 75 lb. to 85 lb. rail.....	B-10242	50
1a	Right Hand Steel Filler, for 4-hole joint, for 90 lb. to 100 lb. rail.....	"	65
2	Left Hand Steel Filler, for 4-hole joint for 75 lb. to 85 lb. rail.....	"	50
2a	Left Hand Steel Filler, for 4-hole joint, for 90 lb. to 100 lb. rail.....	"	65
3	Left Hand Steel Filler, for 6-hole joint, for 75 lb. to 85 lb. rail.....	"	60
3a	Left Hand Steel Filler, for 6-hole joint, for 90 lb. to 100 lb. rail.....	"	75
4	Right Hand Steel Filler, for 6-hole joint, for 75 lb. to 85 lb. rail.....	"	60
4a	Right Hand Steel Filler, for 6-hole joint, for 90 lb. to 100 lb. rail.....	"	75

DETAILS OF KEYSTONE INSULATED RAIL JOINT

The prices quoted below are for parts for A. S. C. E. rails. Prices for parts for other sections will be furnished on application.
 For general drawing of Keystone Insulated Rail Joint see Plate 2425.

Order by Plate and Figure

The drawing references are shown merely for convenience in checking material with shipping lists and invoices.

Fig.		Drawing Reference	List Price
5	Right Hand Fibre Insulation, for 4-hole joint, for 75 lb. to 85 lb. rail.....	B-10304	64
5a	Right Hand Fibre Insulation, for 4-hole joint, for 90 lb. to 100 lb. rail.....	"	70
6	Left Hand Fibre Insulation, for 4-hole joint, for 75 lb. to 85 lb. rail.....	"	64
6a	Left Hand Fibre Insulation, for 4-hole joint, for 90 lb. to 100 lb. rail.....	"	70
7	Left Hand Fibre Insulation, for 6-hole joint, for 75 lb. to 85 lb. rail.....	"	84
7a	Left Hand Fibre Insulation, for 6-hole joint, for 90 lb. to 100 lb. rail.....	"	90
8	Right Hand Fibre Insulation, for 6-hole joint, for 75 lb. to 85 lb. rail.....	"	84
8a	Right Hand Fibre Insulation, for 6-hole joint, for 90 lb. to 100 lb. rail.....	"	90
9	Steel Splice Bar, for 4-hole joint, for 75 lb. to 85 lb. rail.....	B-10242	2 90
9a	Steel Splice Bar, for 4-hole joint, for 90 lb. to 100 lb. rail.....	"	3 00
10	Steel Splice Bar, for 6-hole joint, for 75 lb. to 85 lb. rail.....	"	3 60
10a	Steel Splice Bar, for 6-hole joint, for 90 lb. to 100 lb. rail.....	"	3 70

DETAILS OF KEYSTONE INSULATED RAIL JOINT

The prices quoted below are for parts for A. S. C. E. rails. Prices for parts for other sections will be furnished on application.
 For general drawing of Keystone Insulated Rail Joint see Plate 2425.

Order by Plate and Figure

The drawing references are shown merely for convenience in checking material with shipping lists and invoices.

Fig.		Drawing Reference	List Price
11	End Post, for main rail, for 75 lb. to 100 lb. rail..	B-10245	20
12	End Post, for guard rail, for 75 lb. to 100 lb. rail..	"	40
13	Insulating Bushing for $\frac{3}{4}$ " bolt.....	3-B-10247	14
13a	Insulating Bushing for $\frac{7}{8}$ " bolt.....	1-B-10217	14
13b	Insulating Bushing for 1" bolt.....	2-B-10217	16
14	Steel Washer for $\frac{3}{4}$ " bolt.....	9-B-7824	01
14a	Steel Washer for $\frac{7}{8}$ " bolt.....	10-B-7824	01
14b	Steel Washer for 1" bolt.....	11-B-7824	02
15	Bolt and Nut, $\frac{3}{4}$ "x8- $\frac{1}{2}$ ".....		18
15a	Bolt and Nut, $\frac{7}{8}$ "x8- $\frac{1}{2}$ ".....		26
15b	Bolt and Nut, $\frac{7}{8}$ "x9".....		26
15c	Bolt and Nut, 1"x9".....		36
16	Bolt and Nut, $\frac{3}{4}$ "x13".....		24
16a	Bolt and Nut, $\frac{7}{8}$ "x13".....		32
16b	Bolt and Nut, $\frac{7}{8}$ "x13- $\frac{1}{2}$ ".....		34
16c	Bolt and Nut, 1"x13- $\frac{1}{2}$ ".....		45

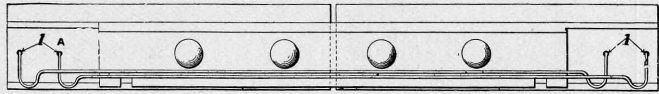

Application A

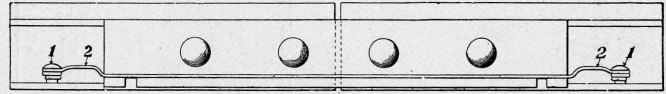

Application C

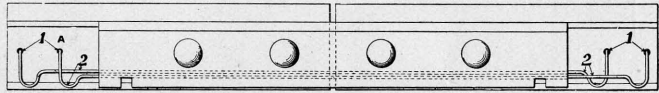

Application B

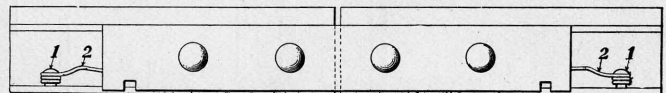

Application D

54

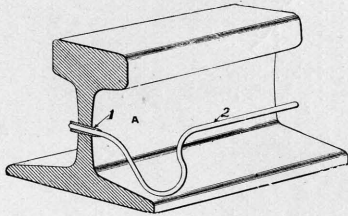

Sectional View of Channel Pin Bonding

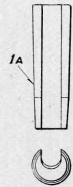

Channel Pin

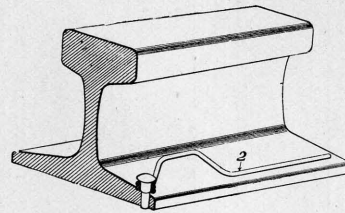

Sectional View of Rivet Bonding

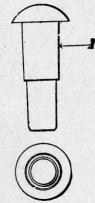

Bond Wire Rivet

METHODS OF APPLICATION OF BOND WIRE RIVETS AND CHANNEL PINS

BOND WIRES, BOND WIRE RIVETS AND CHANNEL PINS

The use of Bond Wires, Bond Wire Rivets and Channel Pins is too well known to require an extended description. Applications of each type are illustrated together with a sectional view of a rivet and of a channel pin connection. Each type has its adherents and is much a matter of preference.

The carrying of the wires outside of the splice bars as in applications A and C, or back of the bars as at B and D, can be adjusted to suit the specifications of the road on which they are to be used. For convenience in ordering the following list has been arranged.

Order by Plate and Figure

Fig.	Drawing Reference	List Price
1	Bond Wire Rivet, per M.....	6 50
1a	Channel Pin for Nos. 2 to 2d and 2k to 2r inclusive, per M.....	12 25
2	48" B. W. G., No. 8 E. B. B. Gal. I. B. Wires, per M.....	34 70
2a	50" B. W. G., No. 8 E. B. B. Gal. I. B. Wires, per M.....	36 00
2b	52" B. W. G., No. 8 E. B. B. Gal. I. B. Wires, per M.....	37 40
2c	60" B. W. G., No. 8 E. B. B. Gal. I. B. Wires, per M.....	42 90
2d	108" B. W. G., No. 8 E. B. B. Gal. I. B. Wires, per M.....	75 70
2k	48" B. & S. G. No. 6 Copper Bond Wires, per M.....	196 00
2m	50" B. & S. G. No. 6 Copper Bond Wires, per M.....	204 00
2n	52" B. & S. G. No. 6 Copper Bond Wires, per M.....	212 00
2p	60" B. & S. G. No. 6 Copper Bond Wires, per M.....	244 00
2r	108" B. & S. G. No. 6 Copper Bond Wires, per M.....	437 00
3	48" B. W. G., No. 8 E. B. B. Track wire with rivets, per M.....	80 00
3a	50" B. W. G., No. 8 E. B. B. Track wire with rivets, per M.....	81 00
3b	52" B. W. G., No. 8 E. B. B. Track wire with rivets, per M.....	82 00
3c	60" B. W. G., No. 8 E. B. B. Track wire with rivets, per M.....	88 00
3d	108" B. W. G., No. 8 E. B. B. Track wire with rivets, per M.....	121 00
3e	48" B. W. G., No. 9 E. B. B. Track wire with rivets, per M.....	73 00
3f	50" B. W. G., No. 9 E. B. B. Track wire with rivets, per M.....	74 00
3g	52" B. W. G. No. 9 E. B. B. Track wire with rivets, per M.....	75 00
3h	60" B. W. G., No. 9 E. B. B. Track wire with rivets, per M.....	79 00
3j	108" B. W. G., No. 9 E. B. B. Track wire with rivets, per M.....	106 00
3k	48" B. & S. G., No. 6 Copper Track Wires with rivets, per M.....	260 00
3m	50" B. & S. G. No. 6 Copper Track Wires with rivets, per M.....	268 00
3n	52" B. & S. G., No. 6 Copper Track Wires with rivets, per M.....	276 00
3p	60" B. & S. G., No. 6 Copper Track Wires with rivets, per M.....	308 00
3r	108" B. & S. G., No. 6 Copper Track Wires, with rivets, per M.....	502 00

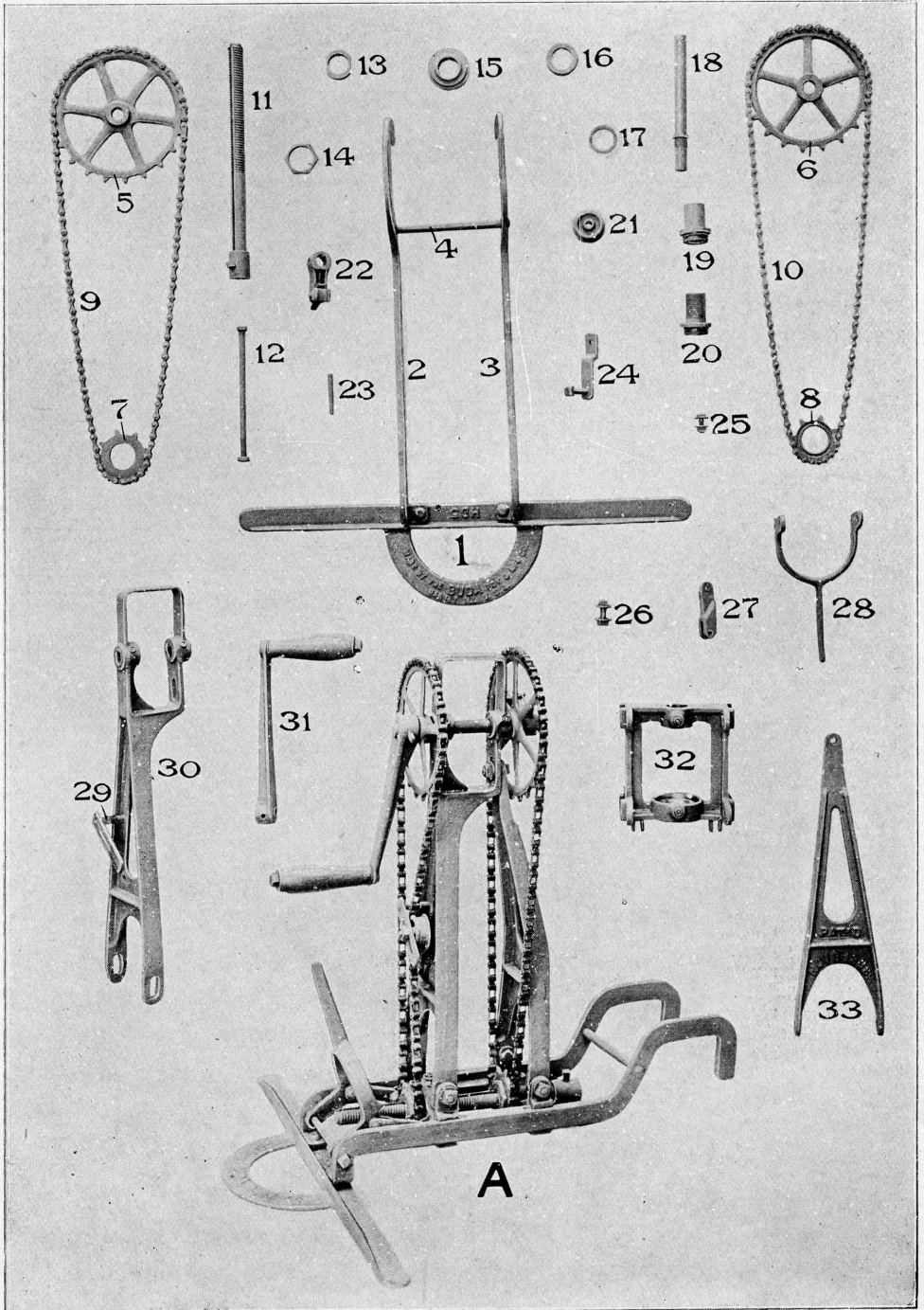

TRACK DRILLING MACHINE

TRACK DRILLING MACHINE

Order by Plate and Figure

Fig.	Drawing Reference	List Price
A	Track Drilling Machine, complete; (for use in drilling web of rail).....	66 60
1	Foot Plate.....	2 00
2	Left Hand Rail Hook.....	} 2 70
3	Right Hand Hook.....	
4	Separator for Nos. 2 and 3.....	
5	Drive Sprocket Wheel (21 teeth).....	4 00
6	Feed Sprocket Wheel (19 teeth).....	3 34
7	Drive Sleeve Sprocket Wheel (8 teeth).....	3 20
8	Feed Nut Sprocket Wheel (7 teeth).....	3 20
9	48 Link Drive Chain.....	2 28
10	47 Link Feed Chain.....	2 28
11	Spindle, with set screw.....	3 34
12	3/8"x6-1/2" Toggle Lever Bolt, with nut and washers.	1 07
13	Adjusting Nut.....	1 20
14	Lock Nut for Nos. 7 and 8.....	67
15	Ball Bearing Cone.....	2 00
16	Collar for drive sleeve No. 19.....	40
17	Washer for adjusting nut No. 13.....	23
18	Crank Shaft.....	1 60
19	Drive Sleeve for No. 11.....	4 80
20	Feed Nut for No. 11.....	4 80
21	Idler Wheel.....	27
22	Pawl and Arm, with 1 of No. 23, for feed sprocket wheel No. 6.....	3 20
23	Crank Shaft Pin for securing Nos. 22 and 31 to No. 18.....	20
24	Idler Wheel Bracket, with pin, nut and washer....	54
25	1/4"x3/4" Bolt, with nut and washers, for securing No. 24 to No. 29.....	66
26	3/8"x1" Bolt, with nut and washers, for securing Nos. 30 to 33 to No. 32, and No. 30 to No. 33...	10
27	Toggle Link, with rivets.....	80
28	Toggle Lever.....	1 60
29	Idler Adjusting Plate, with riveted pin.....	54
30	Upright Frame.....	4 00
31	Crank, with handle.....	1 72
32	Sliding Frame, with oilers and cups for ball bearings.....	8 70
33	Upright Frame Brace.....	2 00
34	Balls for bearing per Set of 20.....	90

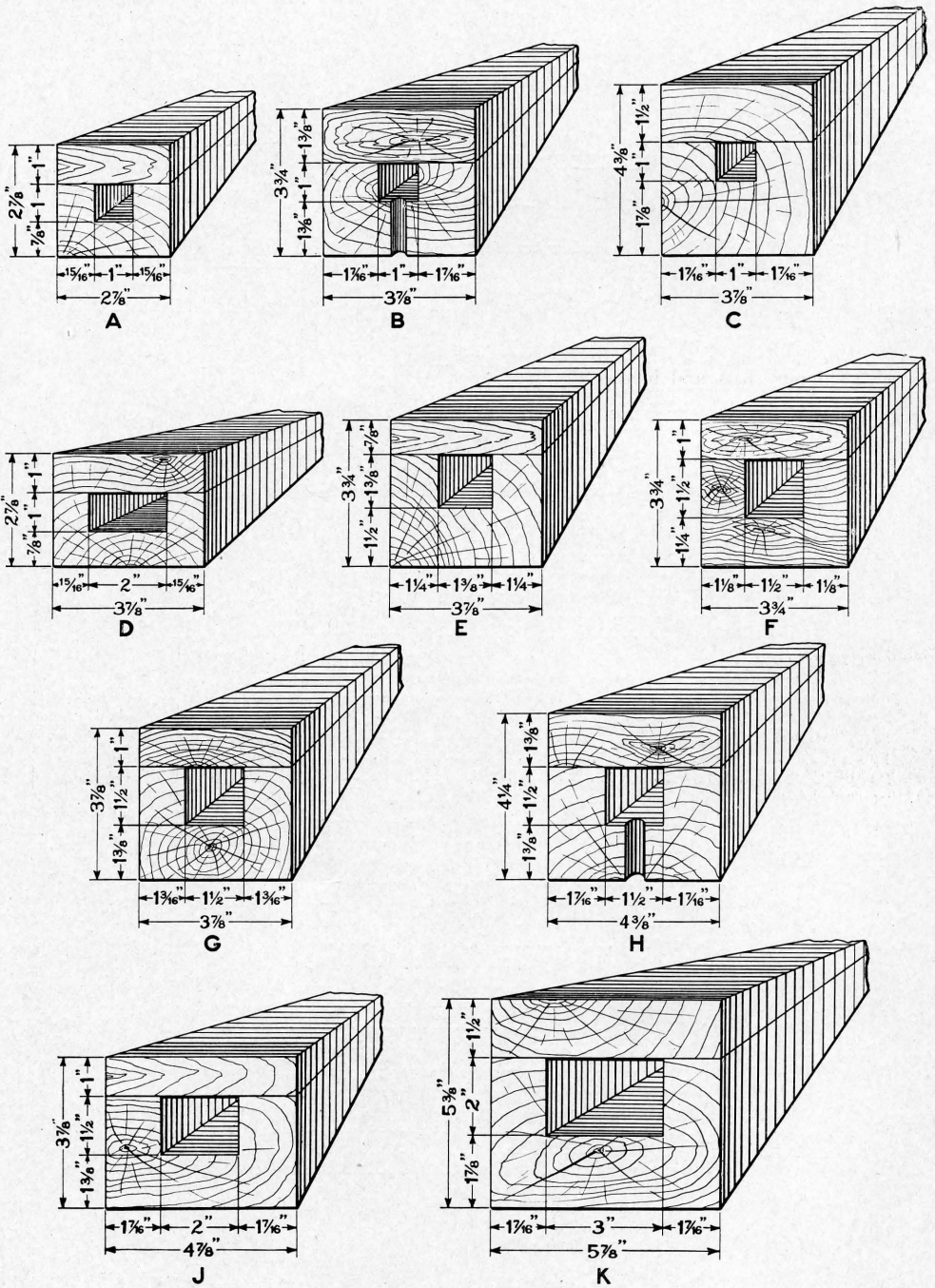

YELLOW PINE TRUNKING FOR WIRE LEADS

YELLOW PINE TRUNKING FOR WIRE LEADS

Order by Plate and Figure

The drawing references are shown merely for convenience in checking material with shipping lists and invoices.

Fig.	Description	Drawing Reference	List Price
A	Grooved Trunking, 1"x1" opening, with capping—per 100 lin. ft.....	1-B-3568	7 50
Aa	Capping only, for Fig. A, per 100 lin. ft.....	"	2 80
B	Grooved Trunking, 1"x1" opening and bored each two feet for drainage, with capping—per 100 lin. ft.....	26-B-3568	13 20
Ba	Capping only, Fig. B, per 100 lin. ft.....	"	4 50
C	Grooved Trunking, 1"x1" opening, with capping—per 100 lin. ft.....	19-B-3568	12 70
Ca	Capping only, for Fig. C, per 100 lin. ft.....	"	4 50
D	Grooved Trunking, 1"x2" opening, with capping—per 100 lin. ft.....	2-B-3568	9 50
Da	Capping only, for Fig. D, per 100 lin. ft.....	"	3 50
E	Grooved Trunking, 1-3/8"x1-3/8" opening, with capping—per 100 lin. ft.....	18-B-3568	11 60
Ea	Capping only, for Fig. E, per 100 lin. ft.....	"	3 50
F	Grooved Trunking, 1-1/2"x1-1/2" opening, with capping—per 100 lin. ft.....	37-B-3568	11 60
Fa	Capping only, for Fig. F, per 100 lin. ft.....	"	3 50
G	Grooved Trunking, 1-1/2"x1-1/2" opening, with capping—per 100 lin. ft.....	4-B-3568	11 60
Ga	Capping only, for Fig. G, per 100 lin. ft.....	"	3 50
H	Grooved Trunking, 1-1/2"x1-1/2" opening, bored each two feet for drainage, with capping—per 100 lin. ft.....	25-B-3568	15 90
Ha	Capping only, for Fig. H, per 100 lin. ft.....	"	5 40
J	Grooved Trunking, 1-1/2"x2" opening, with capping—per 100 lin. ft.....	20 B-3568	14 00
Ja	Capping only, for Fig. J, per 100 lin. ft.....	"	4 10
K	Grooved Trunking, 2"x3" opening, with capping—per 100 lin. ft.....	16-B-3568	21 30
Ka	Capping only, for Fig. K, per 100 lin. ft.....	"	6 30

INDEX

	Plate.	Page.
Appurtenances, Direct Current Crossing Bell.....	2409	16-17
Bell, Crossing, The Union Electric Direct Current. (Iron Pipe Post).....	2401	8- 9
Bell, Crossing, The Union Electric Direct Current.	2403	10-11
Bell, " " " " " " " (Wooden Post).....	2407	14-15
Bell, Union Electric Direct Current Details.....	2405	12-13
Bells, Electric—Typical Forms.....	2411	18-19
Bell, Crossing Alternating Current.....		37
Bell, " " " Details.....	2421	40-41
Bell, Crossing The Union Electric Alternating Current. (Iron Pipe Post).....	2409	38-39
Channel Pins.....	2429	54-55
Chutes, Cast Iron Battery.....	2417	26-27
Introduction		3
Installation		5
Inspection and Maintenance.....		6- 7
Joint, Keystone Insulated Rail.....	2425	48-49
Joint, " " " Details.....	2427	50-51-52-53
Layout, Single Track Direct Current Crossing Bell. (List of Material).....		28-29
Layout, Double Track Direct Current Crossing Bell. (List of Material).....		30-31
Layout, Special Direct Current Crossing Bell.....		32-33
Layout, " " " " " " ".....		34-35-36
Layout, Single Track Alternating Current Crossing Bell		44-45
Layout, Double Track Alternating Current Crossing Bell		46-47
Maintenance and Inspection.....		6- 7
Machine, Track Drilling.....	2431	56-57
Proposals, D. C.....		4
Pins, Channel.....	2429	52-53
Relay, Direct Current Enclosed Universal Interlocking.	2413	20-21
Relay, The Operation of the Interlocking.....		22-23
Relay, 7-C, Direct Current Enclosed.....	2415	24-25
Relay, Alternating Current Enclosed Interlocking.....	2423	42-43
Rivets, Bond Wire.....	2429	54-55
Trunking, Yellow Pine for Wire Leads.....	2433	58-59
Wire, Bond.....	2429	54-55

