

CATALOGUE NO. 1 & PRICE LIST

# THE HALL SIGNAL COMPANY



NEW YORK — CHICAGO

COPYRIGHTED BY  
THE HALL SIGNAL CO.  
1901.



#3

CATALOGUE NO. 4 AND PRICE LIST

...of...

Automatic Electric Disc

...and...

Semaphore Signaling Apparatus

Manufactured by

THE HALL SIGNAL COMPANY

---

Works: GARWOOD, N. J.

---

Offices:

NEW YORK

CHICAGO

---

1901

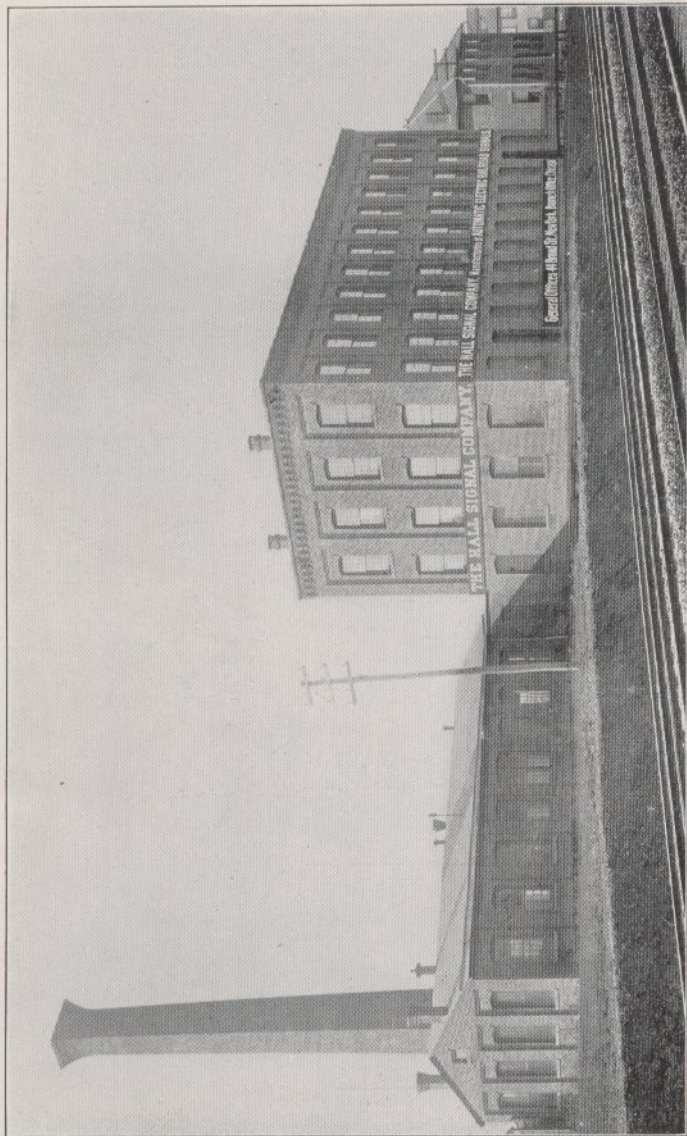

The Hall Signal Co.'s Factory at Garwood, N. J.



## PREFACE



AS the principles of automatic, electric, block signaling are now generally understood by railway men, we have thought it needless to illustrate circuits and to give a mass of descriptive matter such as has appeared in former editions of our catalogue. Therefore, in the preparation of this edition, our sole aim has been to provide railway officials with the means for readily and plainly designating any apparatus which they may wish to order or upon which they may desire to have us quote prices.

We wish, however, to call attention to the fact that we install automatic, electric, disc or semaphore signals on either the "Normal Safety" or "Normal Danger" plans, with or without the use of line wires.

It may be well for us to add that we are advised by our Counsel and that we believe we are the sole and exclusive owners of United States Letters Patent covering the only known, practicable methods of operating automatic signals on the so-called "Normal Danger" plan, and the so-called Buchanan or anti-lightning relay.

We believe that, with the above named patents as well as many others of great value, and with the experience gained in the installation of more than 80 per cent. of all the automatic, electric block signals on the railroads of the United States since 1890, we are justified in claiming to be more competent than any other company to furnish economical, efficient and reliable systems of automatic signals.



THE HALL SIGNAL CO.



## CLASSIFICATION.

---

SECTION No.	PAGE.
1.	. . . . .
2.	. . . . .
3.	. . . . .
4.	. . . . .
5. Style A Disc Signal Instrument . . . . .	11
6. Style B Disc Signal Instrument . . . . .	15
7. Indicator Instrument . . . . .	21
8.	. . . . .
9.	. . . . .
10.	. . . . .
11. Motor Signal Mechanism, Style "W" . . . . .	25-27
12.	. . . . .
13. Dash Pots . . . . .	29-31
14.	. . . . .
15.	. . . . .
16. Motor Signal Mechanism, Style "C" . . . . .	33-35
17. Motor Signal Mechanism, Style "D" . . . . .	37-39-41
18. Revolving Signal Mechanism, Style "B" . . . . .	43-45
19.	. . . . .
20. Relays . . . . .	47-51
21.	. . . . .
22. Double Circuit Instrument . . . . .	53
23.	. . . . .
24.	. . . . .
25. Single Track Interlocking Relay . . . . .	55
26.	. . . . .
27. Switch Lock, Style "A" . . . . .	59

## Classification—Continued.

SECTION No.	PAGE.
28. Switch Lock, Style "B" . . . . .	61
29. Electric Slot . . . . .	63
30. Electric Bells . . . . .	65
31. Lever Locks . . . . .	67-69
32. . . . .	
33. . . . .	
34. . . . .	
35. Track Instruments . . . . .	71-73
36. Switch Instruments . . . . .	75
37. Commutators . . . . .	79-81
38. Bell Frames, Solid Post . . . . .	83
39. Bell Frames, Hollow Post . . . . .	83
40. Disc Signal Fittings . . . . .	85-87
41. Disc Signal, Complete, with Wood Post . . . . .	89
42. Iron Pole for Disc Signal . . . . .	91
43. . . . .	
44. Iron Pole Semaphore Signal Fittings . . . . .	93-95-97
45. . . . .	
46. Wood Pole Semaphore Signal Fittings . . . . .	99-101-103
47. Semaphore Signal, Complete, Wood Pole . . . . .	107
48. . . . .	
49. . . . .	
50. Battery Receptacles . . . . .	111
51. . . . .	
52. . . . .	
53. . . . .	
54. . . . .	
55. Battery Material . . . . .	113-115
56. . . . .	
57. . . . .	
58. . . . .	
59. . . . .	

## Classification—Continued.

SECTION No.	PAGE.
60. Boxes . . . . .	117-119
61. . . . .	
62. . . . .	
63. . . . .	
64. . . . .	
65. Trunking, Channel Pins, Drills, etc. . . . .	121
66. . . . .	
67. Drilling Machines . . . . .	123-125
68. . . . .	
69. . . . .	
70. Lightning Arresters . . . . .	127
71. . . . .	
72. . . . .	
73. . . . .	
74. . . . .	
75. . . . .	
76. . . . .	
77. . . . .	
78. . . . .	
79. . . . .	
80. . . . .	
81. . . . .	





## ILLUSTRATIONS.

	PAGE.
Works . . . . .	Frontispiece
Disc Signal Instrument, Style A . . . . .	12
Hold Clear Disc Signal Instrument . . . . .	13
Disc Signal Instrument, Style B . . . . .	16
Disc Signals on the Illinois Central Railroad . . . . .	17
Disc Signal Instrument, C. & N. W. Style . . . . .	18
Indicator Instrument . . . . .	22
Disc Signals on the Lehigh Valley Railroad . . . . .	23
Motor Mechanism, Style W . . . . .	26
Motor Mechanism, Single Signal, Style C . . . . .	34
Motor Mechanism, Double Signal, Style D . . . . .	38
Motor Mechanism, Double Signal, Style D, in box . . . . .	40
Electric Signals in Subway, Philadelphia . . . . .	44
Standard Relay . . . . .	48
Polarized Relay . . . . .	49
Disc Signal on the New York, New Haven & Hartford R. R. . . . .	56
Single Track Interlocking Relay . . . . .	57
Track Instrument . . . . .	72
Switch Instrument . . . . .	76
Electric Switch Lock, Style B. . . . .	77
Electric Semaphore Signals on the Lehigh Valley Railroad . . . . .	94
Electric Semaphore Signals on the Chicago & Alton R. R. . . . .	96
Electric Semaphore Signals on the Illinois Central R. R. . . . .	100
Electric Semaphore Signals on the Lehigh Valley R. R. . . . .	102
Lever Lock for National Machine . . . . .	114
Lightning Arrester, Style E-G . . . . .	128
Standard Relay, Glass Enclosed . . . . .	129
Commutator Instrument, Style A . . . . .	130
Signal Case, with Style B Instrument . . . . .	131
Volt Am-Metre . . . . .	132
Standard Disc Signals . . . . .	133

### Disc Signal Instrument, Style A.

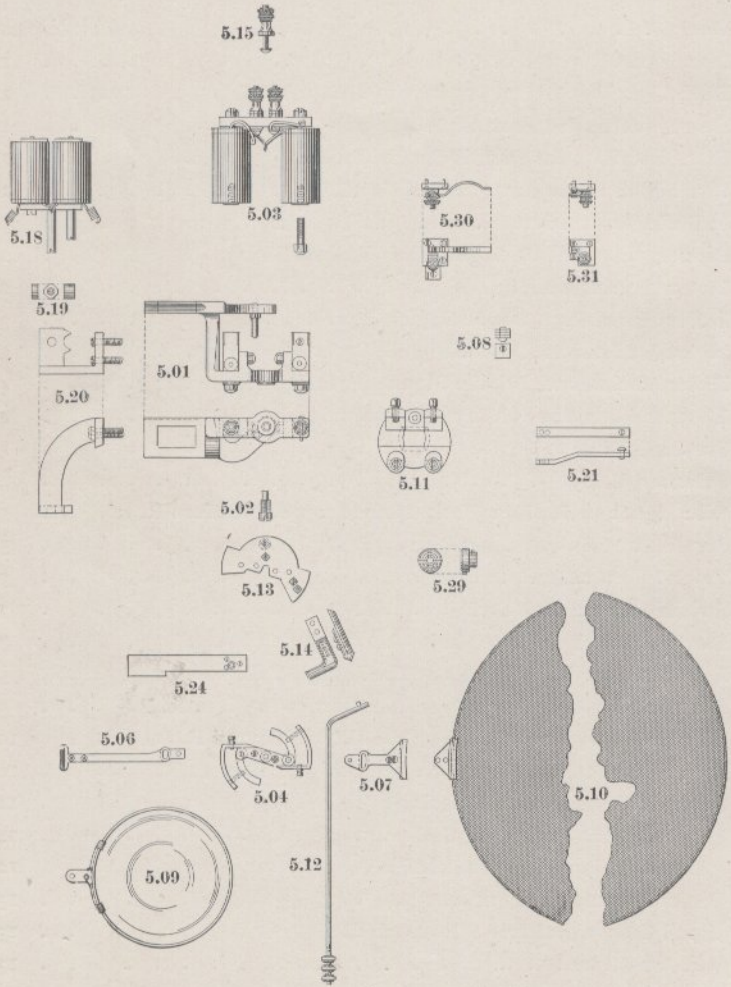

Order No.	DISC SIGNAL.		Price.
	Section 5.	Style A (old).	
5.00	Signal Instrument, complete.....		\$75.00
5.01	Frame, with pole pieces .....		20.00
5.02	Pivot Screw for armature .....		<del>25</del> 25
5.03	Magnets.....		12.00
5.04	Circular Armature .....		15.00
5.06	Arm for glass disc, with screws.....		1.25
5.07	Clamp for cloth disc .....		.75
5.08	Counterweight.....		.15
5.09	Glass Disc (give color) same as 6.c9.....		2.50
5.10	Cloth Disc (give color) same as 6.10.....		1.50
5.11	Case Clamp, with screws .....		.75
5.12	Counterweight Rod on C. & N. W. style.....		.75
5.13	Brass Plate, with screws, on C. & N. W. style..		1.00
5.14	Clamp for counterweight rod on C. & N. W. style..		.50
5.15	Binding Post, with screws.....		.25
5.18	Hold Clear Magnets, complete.....		10.00
5.19	Large Nuts for adjusting hold clear magnets .....		.10
5.20	Hold Clear Magnet Bracket, with screws .....		1.50
5.21	Disc Counterweight Arm, same as 6.21.....		.15
5.24	Hold Clear Armature, with screws .....		.50
5.29	Cam for spring of circuit closer .....		1.50
5.30	Spring of circuit closer, complete with binding post and block .....		3.50
5.31	Contact Anvil of circuit closer, complete with bind- ing post and block .....		3.50

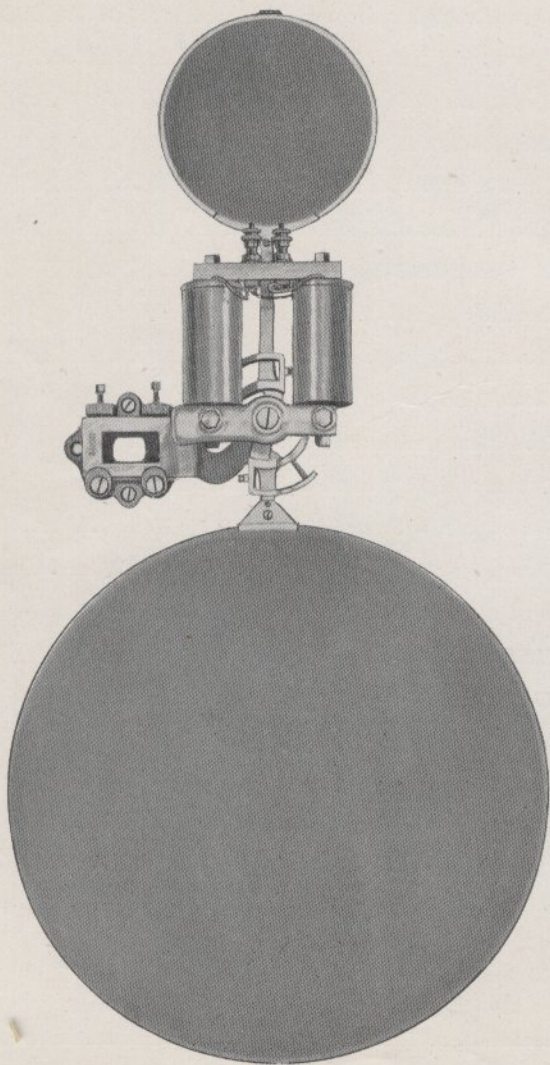
**Disc Signal Instrument, Style A.**

**Hold Clear Disc Signal Instrument.**

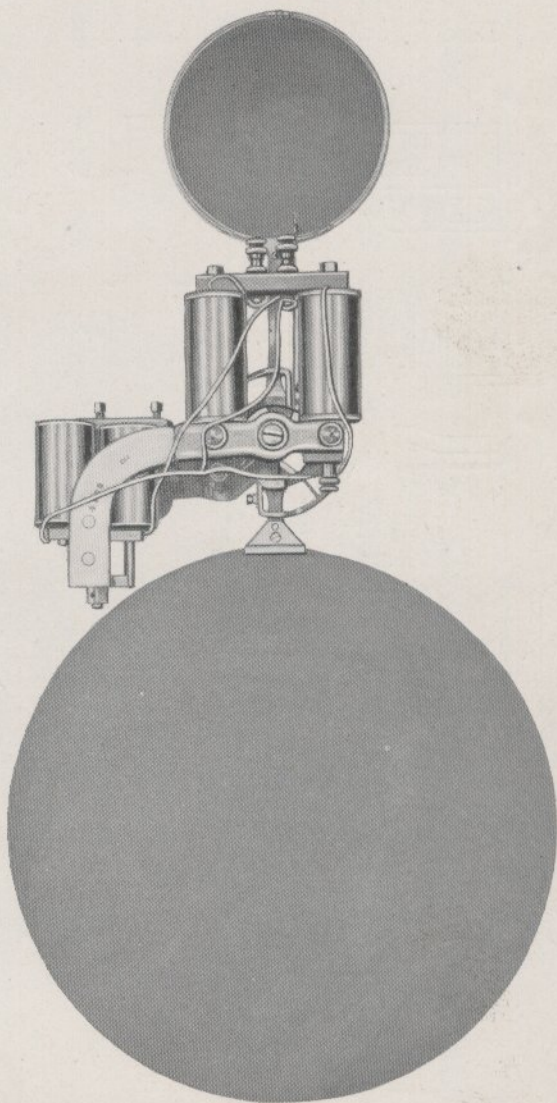

### Disc Signal Instrument, Style B.

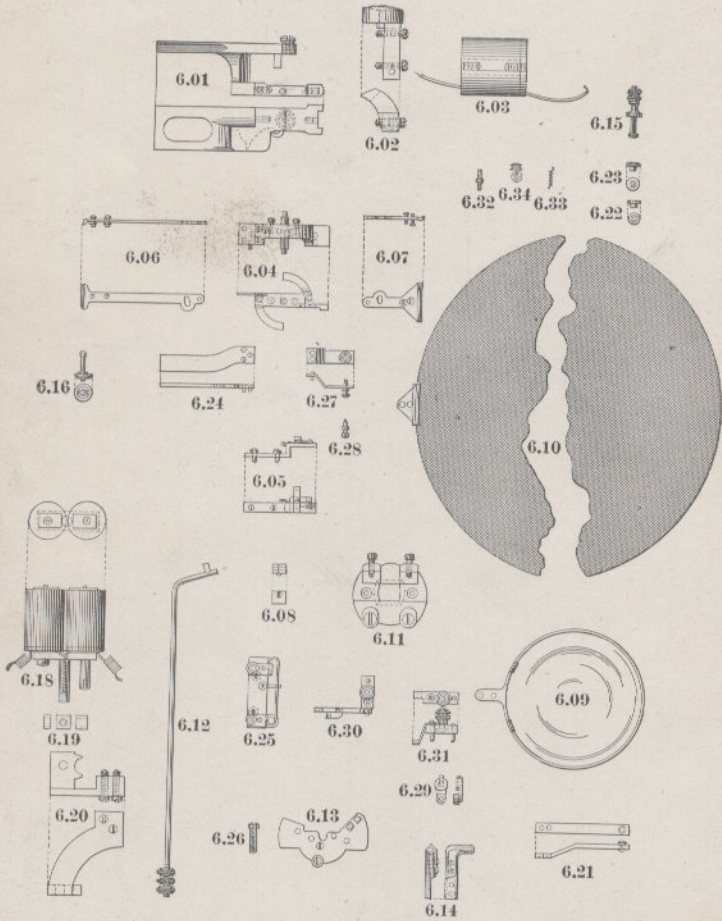

Order No.	DISC SIGNAL. Section 6. Style B (new).	Price.
6.00	Signal Instrument, complete .....	\$75.00
6.01	Frame, with pivot screw .....	15.00
6.02	Pole Piece, with screws .....	5.00
6.03	Magnets, complete .....	11.00
6.04	Armature with shaft .....	16.00
6.05	Latch, complete with screws .....	3.50
6.06	Aluminum Arm, with screws .....	1.25
6.07	Composition Clamp, with screws .....	.75
6.08	Counterweights .....	.15
6.09	Glass Disc (give color) red or green .....	2.50
6.10	Cloth Disc (give color) red or green .....	1.50
6.11	Case Clamp .....	.75
6.12	Counterweight Rod on C. & N. W. style .....	1.00
6.13	Brass Plate on C. & N. W. style, with screws .....	1.75
6.14	Clamp for counterweight rod on C. & N. W. style ..	.50
6.15	Signal Binding Post, with screws .....	.25
6.16	Clamp Screws, with square shoulder nut .....	.10
6.18	Hold Clear Magnets, complete .....	10.00
6.19	Large Nut for adjusting hold clear magnet .....	.10
6.20	Hold Clear Magnet Brackets, with screws .....	1.50
6.21	Disc Counterweight Arm .....	.15
6.22	Small Fibre Bushing .....	.05
6.23	Large Fibre Bushing .....	.05
6.24	Hold Clear Armature, with screws .....	.50
6.25	End Circuit Closer, (state whether open or closed spring is wanted) .....	3.00
6.26	Special Screw, with tapped head .....	.10
6.27	Brass Arm, complete, with bearing screw and nut ..	.50
6.28	Brass Bearing Screw, with bone point and nut .....	.15
6.29	Cam for shaft attachment circuit closer .....	1.00
6.30	Spring, with block and binding post for shaft attach- ment circuit closer .....	1.50
6.31	Contact Anvil, with block and binding post for shaft attachment circuit closer .....	2.00
6.32	Plunger .....	.15
6.33	Plunger Spring .....	.02
6.34	Plunger Screw .....	.03
6.35	End Circuit Closer Comp., with brass arm and all screws .....	3.50
6.36	Complete set of C. & N. W. Attachments, new style ..	6.00

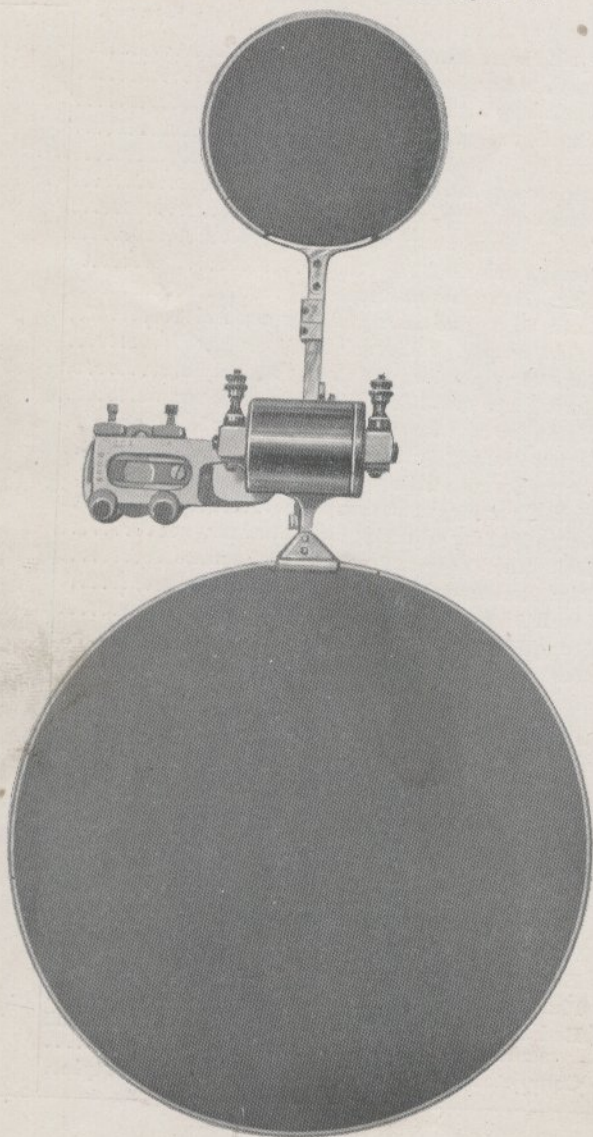
**Disc Signal Instrument, Style B.**



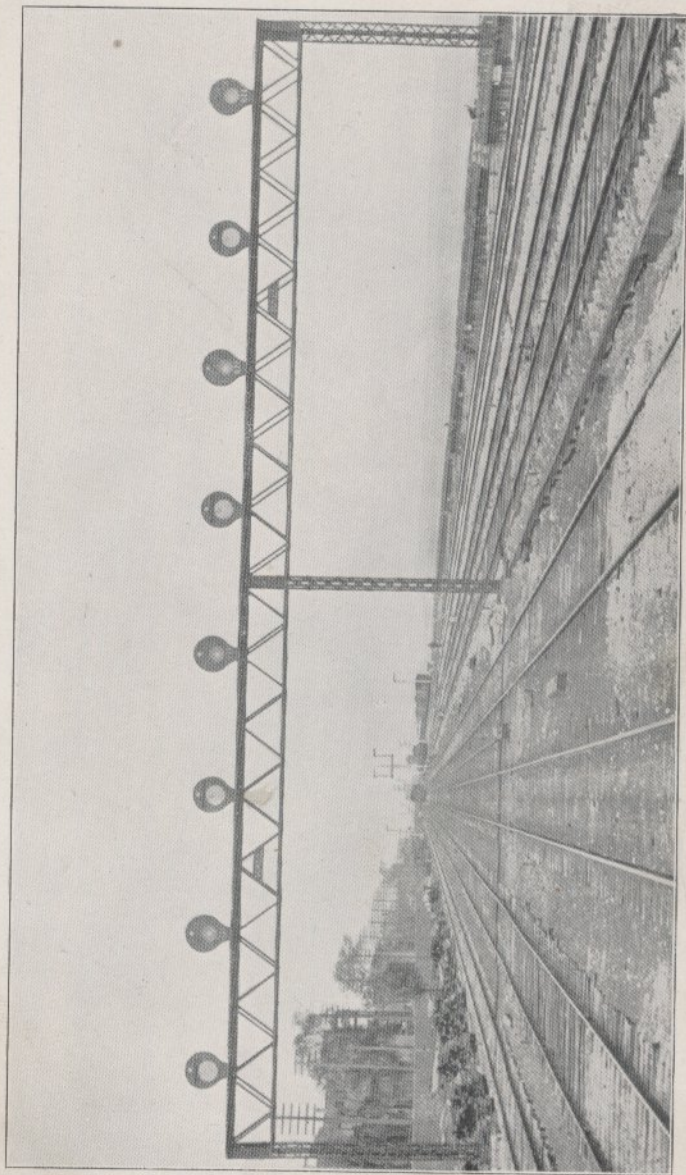

Disc Signals on Illinois Central R. R., Chicago.

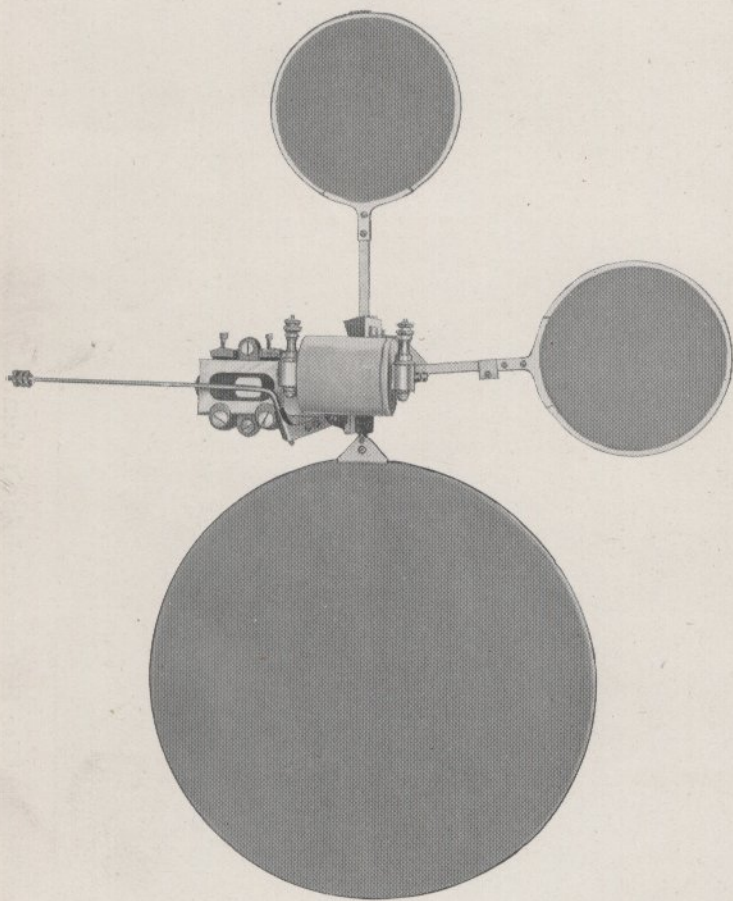
**Disc Signal Instrument, C. & N. W. Style.**

Order No.	<b>Set C. &amp; N. W. Attachments for Old Style Signal Instrument.</b>	Price.
5.13	Brass Plate, complete, with screws and nuts.....	\$1.00
5.06	Arm, with screws and nuts for glass disc.....	1.25
5.14	Aluminum Clamp for counterweight rod.....	.50
5.08	Counterweight.....	.15
5.09	Green Glass Disc.....	2.50
5.12	Balance Rod, with three nuts.....	.75
5.21	Disc Counterweight Arm.....	.15
5.45	Set of Attachments, complete.....	6.00
<b>Set C. &amp; N. W. Attachments for New Style Signal Instrument.</b>		
6.06	Aluminum Arm, with screws and nuts for glass disc.....	1.25
6.08	Counterweight.....	.15
6.09	Green Glass Disc.....	2.50
6.12	Balance Rod, with three nuts.....	.75
6.13	Brass Plate, complete, with screws and nuts.....	.75
6.14	Aluminum Clamp for balance rod.....	.50
6.21	Aluminum Counterweight Arm.....	.15
6.36	Set of Attachments, complete.....	6.00
6.50	C. & N. W. Signal Instrument, complete.....	75.00
6.60	Hold Clear Signal Instrument, complete.....	75.00
6.70	Complete Set of Hold Clear Attachments.....	15.00
<b>Lists of Parts for One Set Hold Clear Attachments for New Style Signal.</b>		
6.08	Counterweight.....	.15
6.18	Hold Clear Magnet, complete.....	10.00
6.19	Large Nut for adjusting Hold Clear magnets.....	.10
6.20	Hold Clear Magnet Bracket, with screws.....	1.50
6.21	Disc Counterweight Arm.....	.15
6.24	Hold Clear Armature, with screws.....	.50
6.26	Special Screws, with tapped heads.....	.10
6.27	Brass Arm, complete with bearing screw and nut and screws.....	.50
6.35	End Circuit Closer, complete.....	3.50
6.70	Complete Set Hold Clear Attachment.....	15.00

## Indicator Instrument.

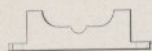

7.08

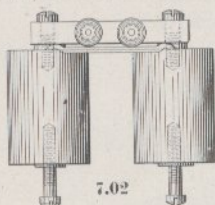

7.02



7.06

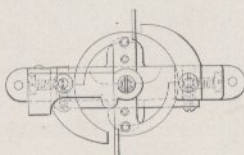

7.01

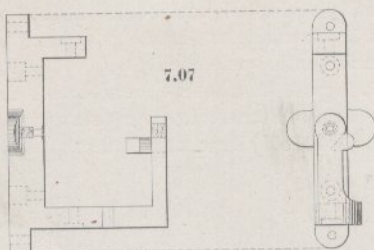

7.07

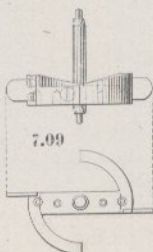

7.09



7.04



7.03

7.05

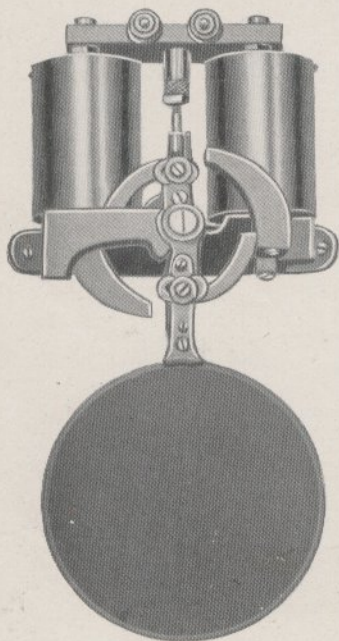

Order No.	INDICATOR INSTRUMENT.	Price.
	<b>Section 7.</b>	
7.00	Indicator Instrument complete.....	\$15.00
7.01	Frame, assembled, with armature, brace and pole pieces .....	6.00
7.02	Magnets, complete (state resistance).....	5.00
7.03	Disc Clamp .....	.10
7.04	Balance Rod, complete, with weight.....	.30
7.05	Balance Weight, only.....	.10
7.06	Cloth Disc.....	.75
7.07	Frame only.....	1.30
7.08	Indicator Brace.....	.35
7.09	Armature, complete with wings and shaft.....	3.00

**Indicator Instrument.**

**Disc Signals on Lehigh Valley R. R.**



# Motor Mechanism, Style W.

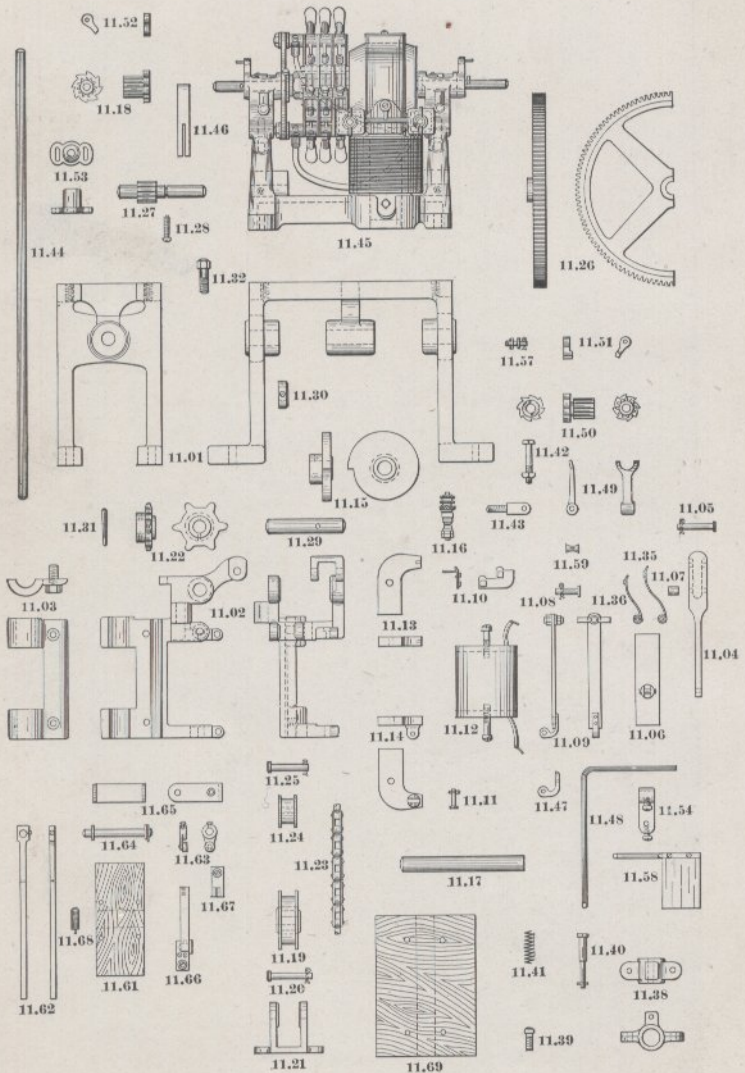

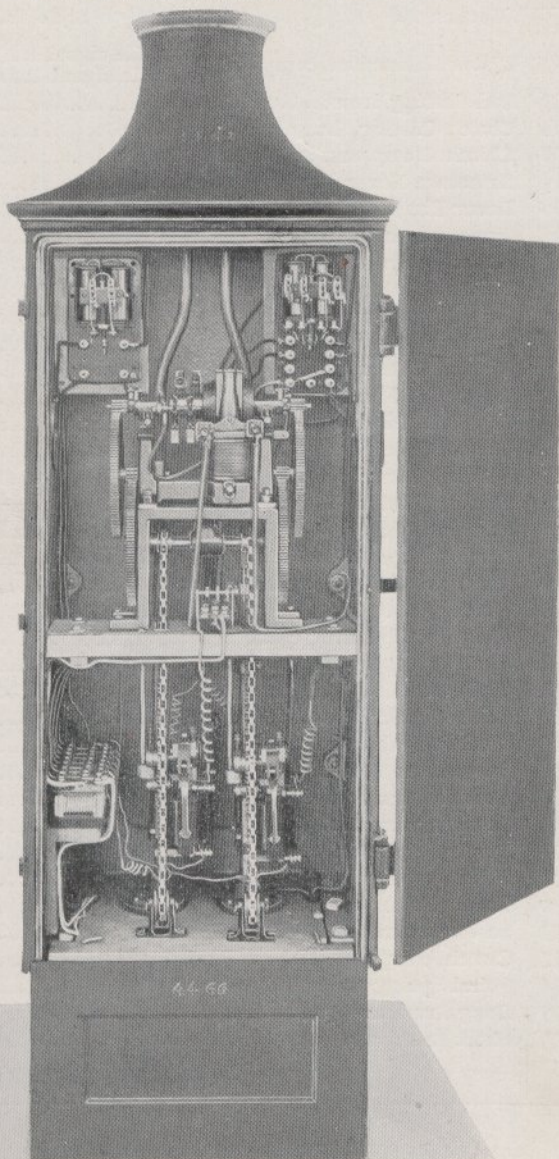

Order No.	MOTOR MECHANISM.		Price.
	Section II.	Style W.	
11.00	Motor Mechanism, complete	{ double signal ..... single signal .....	\$150.00 100.00
11.01	Bed Casting, iron .....		4.00
11.02	Clutch Casting, brass.....		6.00
11.03	Clutch Clamp and Screws.....		.50
11.04	Armature Lever, brass.....		1.00
11.05	Lever Pin and Cotter.....		.07
11.06	Armature and Pin.....		.25
11.07	Roller in armature lever .....		.10
11.08	Pin and Cotter for roller .....		.05
11.09	Side Armature.....		.50
11.10	Anvil, with binding post .....		1.00
11.11	Pin and Cotter for side armature .....		.05
11.12	Magnet and Screws .....		11.00
11.13	Top Pole Pieces.....		.75
11.14	Bottom Pole Pieces .....		.75
11.15	Ratchet Cam, brass.....		.60
11.16	Binding Post, with bushing.....		.25
11.17	Sprocket Shaft and pin for clutch.....		.15
11.18	Small Gear and Ratchet for motor shaft.....		.50
11.19	Tightning Roller for chain.....		.30
11.20	Shaft, with cotter for tightning roller.....		.10
11.21	Stand for tightning roller.....		.15
11.22	Sprocket.....		.75
11.23	Chain.....		1.25
11.24	Guide Roller for chain .....		.50
11.25	Shaft for guide roller.....		.10
11.26	Large Gear Wheel .....		4.00
11.27	Geared Countershaft.....		1.00
11.28	Bearing Screw.....		.01
11.29	Driving Sprocket Shaft.....		.25
11.30	Collar for sprocket shaft.....		.50
11.31	Taper Pin.....		.06
11.32	Screws for motor base.....		.10
11.33	Clutch, complete.....		25.00
11.34	Spiral Spring under front armature.....		.02
11.35	Long Armature Spring.....		1.00
11.36	Short Armature Spring.....		1.06
11.37	.....		

**Motor Mechanism, Style W.**

Order No.	<b>Section II—Continued.</b>	Price.
11.38	Clamp Arm for rod .....	\$0.15
11.39	Screws for clamp arm .....	.02
11.40	Lifting Pin in arm .....	.20
11.41	Spiral Spring for lifting pin .....	.03
11.42	Bolt, with washer for motor frames .....	.05
11.43	Support for rod .....	.20
11.44	Clutch Guide Rod .....	.15
11.45	Motor .....	35.00
11.46	Motor Brushes (state kind), each .....	.35
11.47	Aluminum Lever .....	.15
11.48	Shifter Rod .....	.25
11.49	Shifting Yoke .....	.25
11.50	Shifting Pinion and Ratchet, combined .....	.60
11.51	Pawls for home gears .....	.15
11.52	Pawls for distant gears .....	.15
11.53	Socket for holding clutch guide rod .....	.15
11.54	Composition Holder for circuit breaker rod .....	.50
11.55	Telephone Cord Connections .....	.10
11.56	Lamp Cord Connections .....	.10
11.57	Studs for pawls .....	.15
11.58	Circuit Breakers, complete, with rod .....	1.00
11.59	Rubber Sleeve, with screw .....	.05
11.60	<b>Circuit Closing Device</b> , complete, per spring .....	1.50
11.61	Base for two springs (slate) .....	.15
11.62	Crank Arm, with set screw .....	.25
11.63	Cams, complete .....	.15
11.64	Shafts, with washers and cotters .....	.05
11.65	Upright Brass Bearing for shaft .....	.40
11.66	Circuit Closing Spring, with screws .....	1.00
11.67	Circuit Closing Anvil, with screws .....	.25
11.68	Spiral Spring for circuit closer .....	.02
11.69	Base for six springs (slate) .....	.40

## Oil Dash Pot.

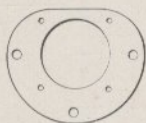

13.01



13.02



13.03



13.05



13.04



13.10



13.17

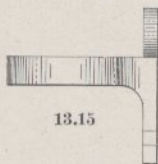

13.15



13.11

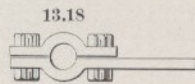

13.18

13.16



13.21

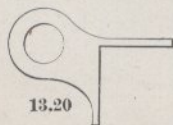

13.20



13.09

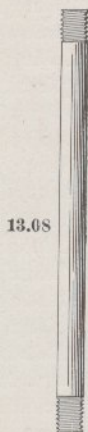

13.08

Order No.	<b>DASH POTS. Section 13.</b>	Price.
13.00	Oil Dash Pot, complete.....	\$6.50
13.01	Cylinder.....	3.25
13.02	Cap.....	.75
13.03	Brass Gland.....	.50
13.04	Piston, complete.....	1.50
13.05	Piston Balls, each.....	.01
13.06	.....	
13.07	.....	
13.08	Piston Pipe only.....	.35
13.09	Oil Hole Screws, each.....	.01
13.10	Screws for cap, each.....	.01
13.11	Flange Bolts, each.....	.01
13.12	.....	
13.13	.....	
13.14	.....	
13.15	.....	
13.16	.....	
13.17	.....	
13.18	.....	
13.19	.....	
13.20	.....	
13.21	$\frac{5}{8}$ " x $3\frac{1}{2}$ " Lag Screws, each.....	.05
13.22	Air Dash Pot, complete, with flange pedestal 13 25..	8.00
13.23	.....	



Order No.	Section 13—Continued.	Price.
13.24	Cylinder, 4½ inch.....	\$4.00
13.25	Piston and Flange Pedestal, complete, 4½ inch.....	4.00
13.26	Iron Air Dash Pot, complete, with bracket pedestal 13.27, 4½ inch.....	8.00
13.27	Piston and Bracket Pedestal, complete, 4½ inch.....	4.00
13.28	Piston and Flange Pedestal, 3⅝ inch.....	3.50
13.29	.....	
13.30	Cylinder only, 3⅝ inch.....	4.00
13.31	Air Dash Pot, complete, with flange pedestal 13.28..	7.00

# Motor Mechanism, Style C.

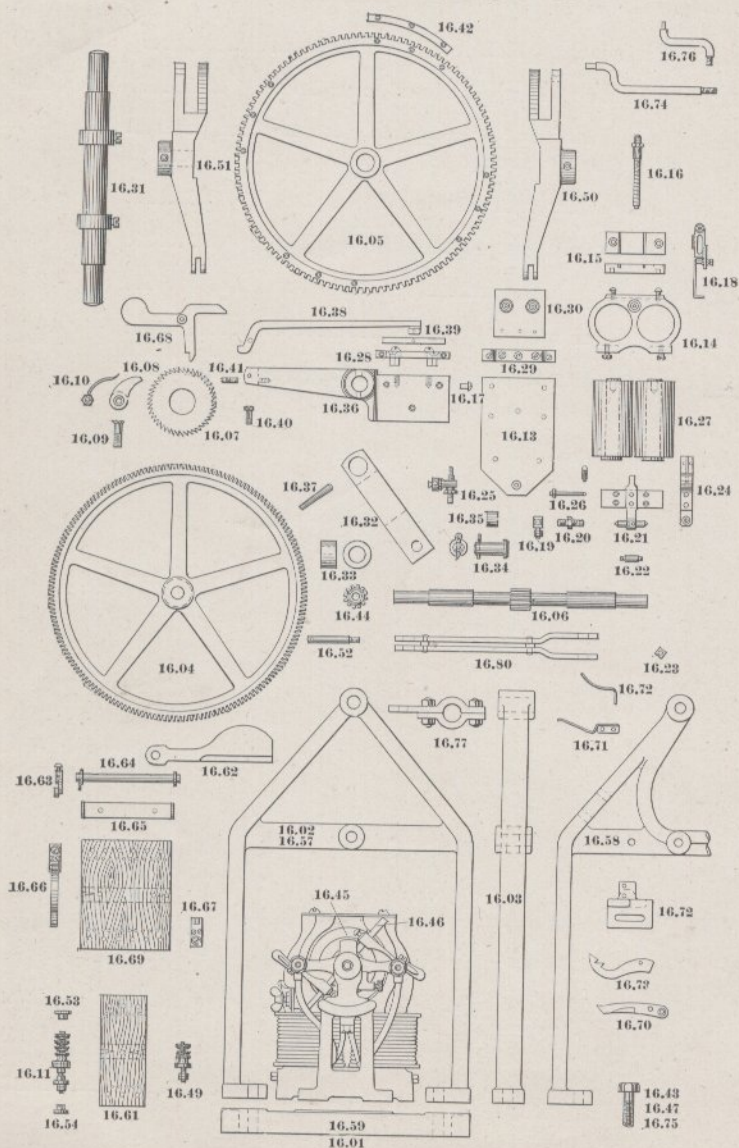

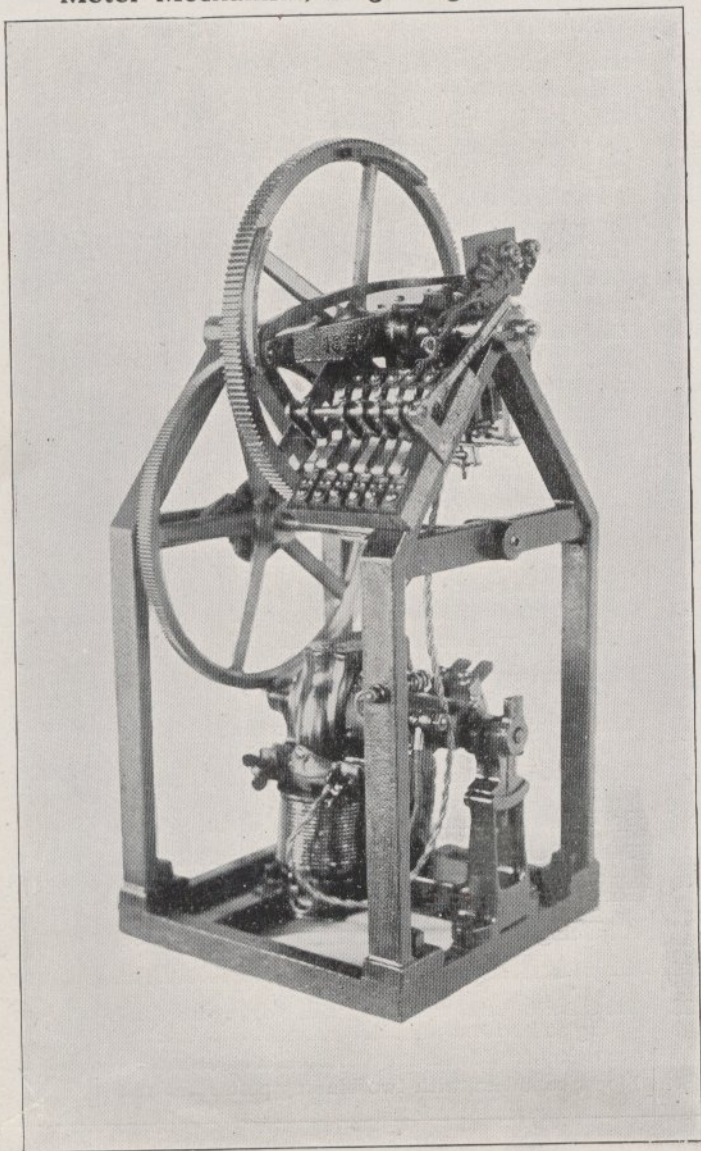

Order No.	MOTOR MECHANISM. Section 16. <span style="float: right;">Style C.</span>	Price.
16.00	Motor Mechanism, complete, single signal.....	\$100.00
16.01	Bed Casting for frame.....	2.00
16.02	Side Casting for frame, right.....	2.50
16.03	Side Casting for frame, left.....	2.50
16.04	Gear Wheel.....	5.00
16.05	Gear Wheel.....	6.50
16.06	Intermediate Shaft and Pinion, combined.....	3.50
16.07	Cast Steel Ratchet Gear.....	.75
16.08	Cast Steel Dog.....	.35
16.09	Large Stud Screw.....	.10
16.10	Phosphor Bronze Spring, with stud.....	.05
16.11	Binding Post, with three nuts.....	.25
16.12	Motor Mechanism, complete, double signal.....	150.00
16.13	Brass Plate.....	.35
16.14 } 20.16 }	Yoke, with rubber bushing, collar and screws.....	.75
16.15 } 20.03 }	Spring Bar.....	.75
16.16 } 20.13 }	Stop Screw, with tube and nuts.....	.15
16.17	Brass Screws, each.....	.01
16.18	Relay Springs.....	1.00
16.19	Brass Feet, with washers and nuts.....	.10
16.20 } 20.07 }	Pivot Screw and Lock Nut.....	.10
16.21 } 20.15 }	Aluminum Lever, with shaft and armature.....	1.00
16.22 } 20.12 }	Bone Insulation for armature.....	.10
16.23 } 20.19 }	Split Nuts for insulations.....	.01
16.24	Split Fingers, with platinum wire contact.....	1.00
20.08 } 16.25 }	Back Stop Post, complete.....	.50
16.26	Adjusting Stem, with nut.....	.05
16.27 } 20.01 }	Magnets.....	10.00
16.28	Brass Back Plate, complete, with Norway iron bushing and screws.....	1.00
16.29	Brass Stand, with screws.....	.30
16.30	Block, complete, with two binding posts.....	.55

**Motor Mechanism, Single Signal, Style C.**

Order No.	Section 16—Continued.	Price.
16.31	Shaft for crank and large gear .....	\$1.00
16.32	Steel Crank.....	1.50
16.33	Collars .....	.35
16.34	Roller Pin, with cotter for crank.....	.20
16.35	Steel Roller.....	.10
16.36	Cast Steel Clutch Arm, Single Signal.....	1.25
16.37	Taper Pin.....	.08
16.38	Steel Armature Lever, with saddle.....	1.50
16.39	Clutch Armature.....	.25
16.40	Steel Screw.....	.10
16.41	Special Screw .....	.05
16.42	Steel Tail-Piece, with screws.....	.35
16.43	Frame Bolts, each .....	.05
16.44	Pinion for motor shaft .....	.50
16.45	Motor only .....	35.00
16.46	Motor Brushes, Gauze Copper Leaf .....	.35
16.47	Cap Bolts.....	.10
16.48	.....	
16.49	Binding Post, with two nuts .....	.25
16.50	Right-hand Clutch Arm for double signal.....	1.50
16.51	Left-hand Clutch Arm for double signal.....	1.50
16.52	Small Crank to engage circuit closer, single signal.....	.10
16.53	Large Fibre Bushing.....	.03
16.54	Small Fibre Bushing.....	.03
16.55	Telephone Cord Connections.....	.08
16.56	Lamp Cord Connections .....	.08
16.57	Right-hand Casting for double signal.....	4.00
16.58	Left-hand Casting for double signal.....	4.00
16.59	Bed Casting for double signal.....	2.50
16.60	<b>Circuit-closing Device</b> , complete, per spring .....	1.50
16.61	Base for three springs (slate).....	.25
16.62	Counterweight Castings.....	.20
16.63	Cam complete.....	.10
16.64	Shaft, with washer and cotter.....	.10
16.65	Upright Brass Bearing for shaft.....	.25
16.66	Circuit-closing Spring, with screws.....	1.00
16.67	Anvil, with screws.....	.50
16.68	Trip Casting, iron.....	.15
16.69	Base for six springs (slate).....	.40
16.70	Pawl, with slot notches.....	1.00
16.71	Spring for pawl.....	.15
16.72	Bracket for latch.....	1.25
16.73	Steel Latch .....	.75
16.74	Crank to engage circuit closer on distant signal.....	.15
16.75	Four Bolts and Washers, $\frac{5}{16}$ " x $2\frac{3}{4}$ ", each .....	.05
16.76	Crank to engage circuit closer, home signal.....	.15
16.77	Clamp for Up and Down Rod.....	.75
16.79	Bolt for clamp.....	.05
16.80	Connecting Link for same.....	.50

# Motor Mechanism, Style D.

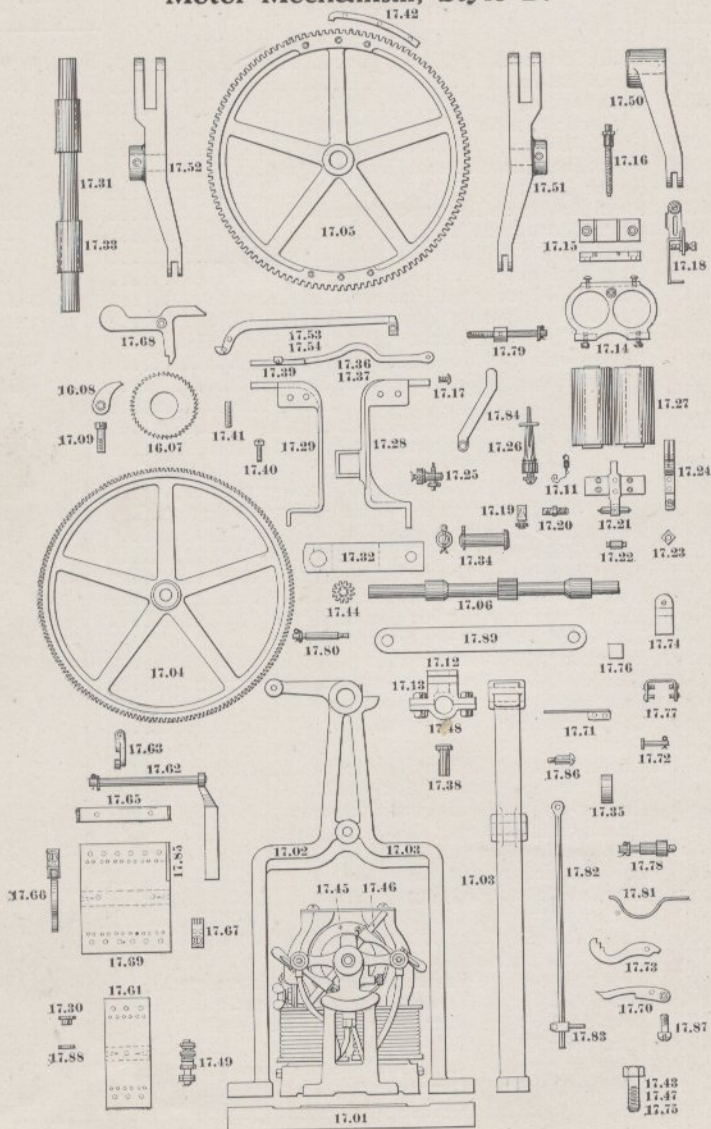

Order No.	<b>MOTOR MECHANISM.</b>		Price.
	<b>Section 17.</b>	<b>Style D.</b>	
17.00	Motor Mechanism, complete, for double signal . . . . .		\$150.00
17.01	Bed Casting for frame . . . . .		2.00
17.02	Right Side Casting . . . . .		2.50
17.03	Left Side Casting . . . . .		2.50
17.04	Intermediate Gear . . . . .		5.00
17.05	Clutch Gear . . . . .		6.50
17.06	Intermediate Shaft and Pinion combined . . . . .		3.50
16.07	Cast Steel Ratchet . . . . .		.75
17.08	Cast Steel Dog . . . . .		.35
17.09	Large Stud Screw . . . . .		.10
17.10	Motor Mechanism complete, for single signal . . . . .		100.00
17.11	Coil Spring . . . . .		.01
17.12	Clamp . . . . .		.20
17.13	Bolts for clamp, each . . . . .		.10
20.16	Yoke, with rubber bushing, collar . . . . .		.75
17.14			
20.03	Spring Bar . . . . .		.75
17.15			
20.13	Stop Screw, with tube and nuts . . . . .		.15
17.16			
17.17	$\frac{3}{8}$ "—6 x 32 Brass Screws, each . . . . .		.01
17.18	Relay Springs . . . . .		1.00
17.19	Brass Feet, with washers and nuts, each . . . . .		.10
20.07	Pivot Screw and Lock Nut . . . . .		.10
17.20			
20.15	Aluminum Lever, with shaft and armature . . . . .		1.00
17.21			
20.12	Bone Insulation for armature . . . . .		.10
17.22			
20.19	Split Nuts for insulation, each . . . . .		.01
17.23			
17.24	Split Fingers, with platinum wire contact . . . . .		1.00
20.08	Back Stop Post, complete . . . . .		.50
17.25			
20.10	Adjusting Post . . . . .		.25
17.26			
20.01	Magnets, per pair . . . . .		10.00
17.27			

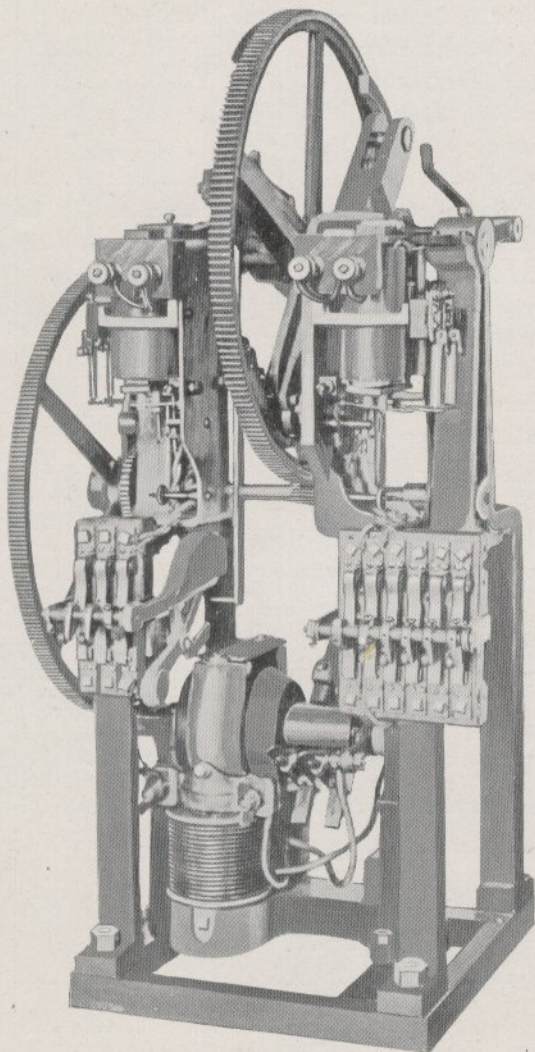
**Motor Mechanism, Double Signal, Style D.**

Order No.	<b>Section 17—Continued.</b>	Price.
17.28	Brass Base, with Norway iron bushings, for home signal .....	\$3.50
17.29	Brass Base, with Norway iron bushings, for distant signal .....	2.50
17.30	Fibre Bushings, each .....	.03
17.31	Crank Shaft .....	1.00
17.32	Steel Crank for outside connected motor .....	1.50
17.33	Sleeves for crank shaft .....	.10
17.34	Crank Pin .....	.10
17.35	Steel Roller.....	.10
17.36	Home Armature Lever, with saddle.....	.50
17.37	Distant Armature Lever, with saddle.....	.50
17.38	Steel Pin for clamp .....	.10
17.39	Clutch Armature.....	.25
17.40	Steel Screw.....	.10
17.41	.....	
17.42	Steel Tail Piece, with screws.....	.35
17.43	Frame Bolts, each.....	.05
17.44	Pinion for motor shaft.....	.50
17.45	Motor only .....	35.00
17.46	Motor Brushes, Gauze or Copper Leaf.....	.35
17.47	Cap Bolts.....	.10
17.48	Clamp.....	.15
17.49	Binding Post, with two nuts.....	.25
17.50	Cast Steel Clutch Arm for outside connected motor.....	1.50
17.51	Cast Steel Clutch Arm for home signal.....	1.50
17.52	Cast Steel Clutch Arm for distant signal.....	1.50
17.53	Home Clutch Lever.....	1.50
17.54	Distant Clutch Lever.....	1.50
17.55	.....	
17.56	.....	
17.57	Armature Counterweights.....	.15
17.58	Pin, with cotter.....	.05

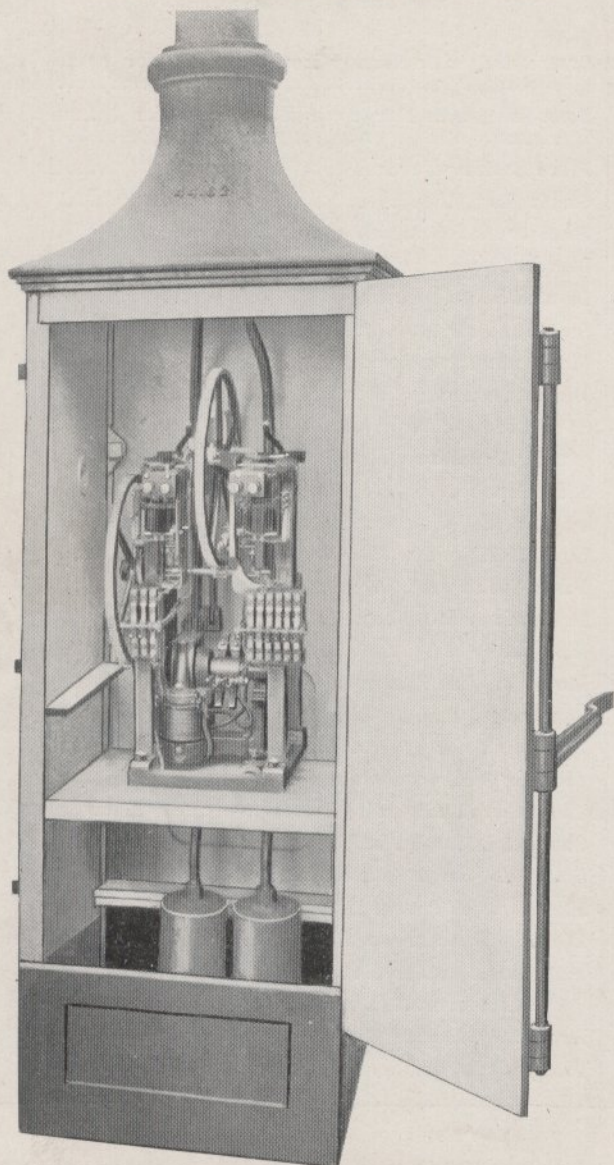
**Motor Mechanism, Style D, in box.**



## Section 17—Continued.

Order No.		Price.
17.59	Shaft bearing three-spring circuit closer, Home.....	
17.60	Circuit Closer, complete, per spring.....	\$1.50
17.61	Slate Base for three springs.....	.25
17.62	Counterweight Lever and Shaft combined.....	.25
17.63	Cam, complete.....	.10
17.64	Shaft bearing three-spring circuit closer, Distant....	
17.65	Upright Brass Bearing for shaft.....	.25
17.66	Circuit Closing Spring, with screws.....	1.00
17.67	Anvil, with screws.....	.50
17.68	Trip Casting.....	.15
17.69	Slate Base for six springs.....	.40
17.70	Pawl.....	1.00
17.71	Spring for Pawl.....	.15
17.72	Pin, with cotter for latch.....	.05
17.73	Steel Latch.....	.75
17.74	Chair for latch.....	.30
17.75	Bolts and Washers for holding device in box, each ..	.05
17.76	Rubber Buffer.....	.25
17.77	Brass Strap and Screws for buffer.....	.20
17.78	Stud for trip roller.....	.15
17.79	Stud for armature lever.....	.15
17.80	Stud for operating circuit closer, with cotter.....	.15
17.81	Spring for latch.....	.05
17.82	Connecting Rod for circuit closer.....	.15
17.83	Clamp Pin for above.....	.05
17.84	Buffer Spring.....	.10
17.85	.....	
17.86	Bearing Stud for trip casting.....	.05
17.87	Stud Screw for pawl.....	.05
17.88	Fibre Washer.....	.01
17.89	Link.....	.55

NIGHT SIGNALLING



SAFETY

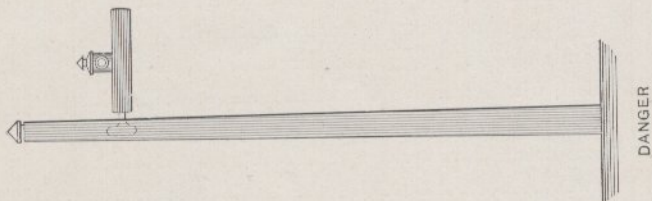

DANGER

DAY SIGNALLING

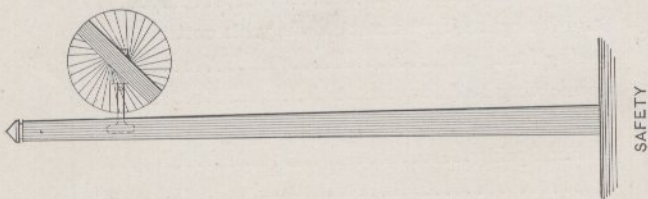

SAFETY



DANGER

**Revolving Signal, Style B.**

## Section 18.

## REVOLVING SIGNAL.

## Style B.

## DESCRIPTION.

The semaphore arm is medially pivoted as shown. An electric motor operates the signal.

The principle of the signal is MOTION, not POSITION. Its language to the engineer is: If I am in motion, you can be; if I have stopped, you must stop.

Describing it as a day signal, its revolution makes it far more distinct with a bad landscape background than a signal at rest in a defined position for safety. You can see a bird flying through a tree, but it is difficult to detect the spot where the bird has settled.

For night signaling, the lantern shown in the drawing gives the usual steady red light for danger, but there is no spectacle in the semaphore to get broken, and thereby show safety when it should be danger, as is the case with the ordinary position semaphore.

The semaphore revolving in front of the bull's eye flashes the light, thus making a SAFETY signal absolutely distinct from all surrounding city lights, and preventing trouble from color blindness.

The engineman knows that the semaphore is revolving, because, by that means the light is flashed.

The semaphore blade makes ten revolutions per minute; therefore, there are twenty obscurations or flashes per minute.

When the light is not being flashed, the engineman knows the semaphore is at rest, indicating danger.

This gives at night substantially what is given in the daytime.

The signal can either be applied as an "automatic" signal or be operated from a signal tower.

For a four-track road, the signal for the inner track could be on the left hand side of the post in line with the signal shown in the cut. As the lamps would be six feet apart, they would plainly indicate their respective tracks. A single post could therefore be used in place of a bracket post.

The usual overlap, or a home and distant signal on the same post, can be supplied.

Normally, the signal is in the horizontal position, signifying DANGER, in the same manner as the ordinary POSITION semaphore. Should it from any cause fail to assume the horizontal position, it is nevertheless

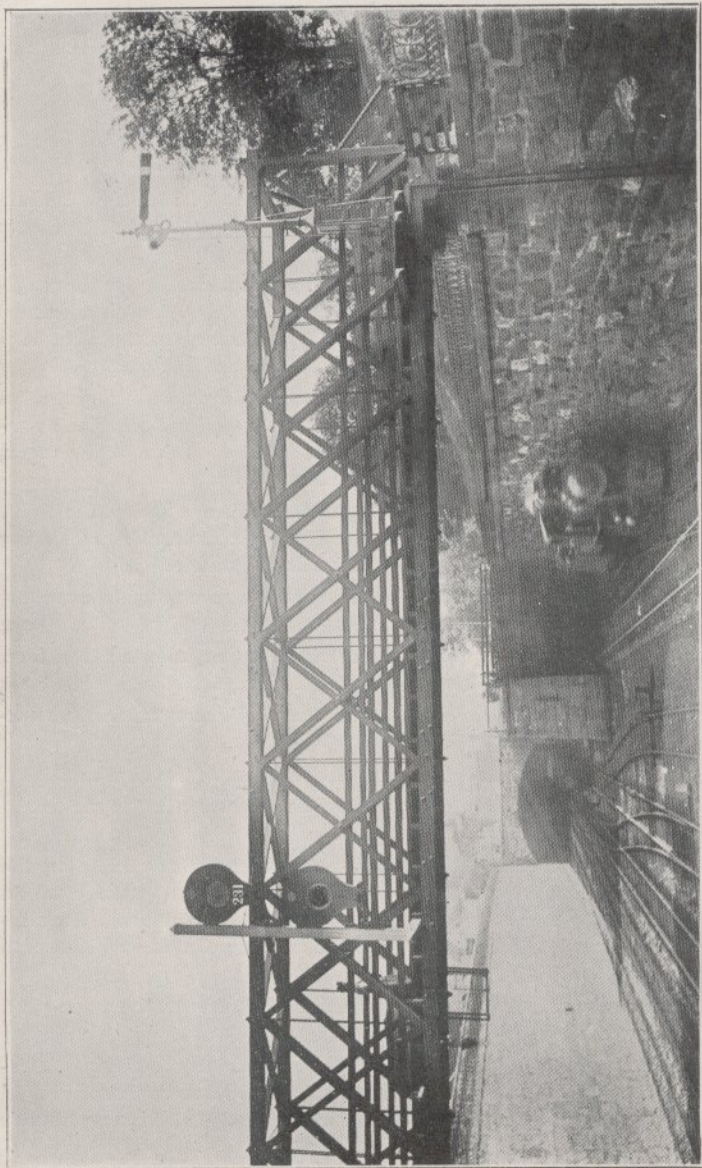

Electric Signals in Subway, Philadelphia.

a DANGER signal, because it is not in motion, but its mechanism stops it in the horizontal position.

The principle of revolving the signal to indicate SAFETY is so utilized in the above signal that the following claims can be justly made. They cannot be claimed in any form of POSITION signal.

1. No dependence upon automatic mechanism in any part of the system to change the signal from the indication of SAFETY to that of DANGER. The presence of a train in the block beyond the signal cuts out the track battery. This is an electrical law and can therefore be depended upon. This source of power being removed, the signal can only complete its last revolution. In doing so it mechanically forces all mechanism in the system to the required condition of the DANGER indication. As the movement of the signal indicates SAFETY, should there not be a movement to the mechanism as above described, the signal is a DANGER signal because it cannot revolve. Therefore, failure from any cause can only indicate DANGER, and it is, therefore, IMPOSSIBLE for this signal to remain at SAFETY behind a train.

2. Foreign currents (say trolley currents) cannot cause a signal to indicate SAFETY behind a train. This is accomplished without extra contact points, relays, or insulated rail joints.

3. Permissive block is safe as regards the signaling system, because it is impossible for a signal to continue at SAFETY behind a train.

4. Sparking by the opening of the motor circuit is not a source of trouble; and should lightning weld any contact points, the signal can only indicate DANGER.

N. B.—When, however, a railroad company requires so long a block, that it is necessary to divide it into sections, at such sectional points the automatic release of the track relay armature would have to be depended upon.

Mr. A. Reasoner, late Superintendent of the Delaware, Lackawanna and Western, has given the following testimonial, dated November 9th, 1898:

“I can state that your revolving signal has worked satisfactorily during a long-time test on our Boonton Branch; and I consider it will fulfill all you claim for it. The feature peculiar to your signal, namely, no dependence upon automatic mechanism to change it from the indication of safety to that of danger, is, in my opinion, all important. This company is not purchasing signals, at the present; meantime, I have your prices before me.”

## Standard Relay.

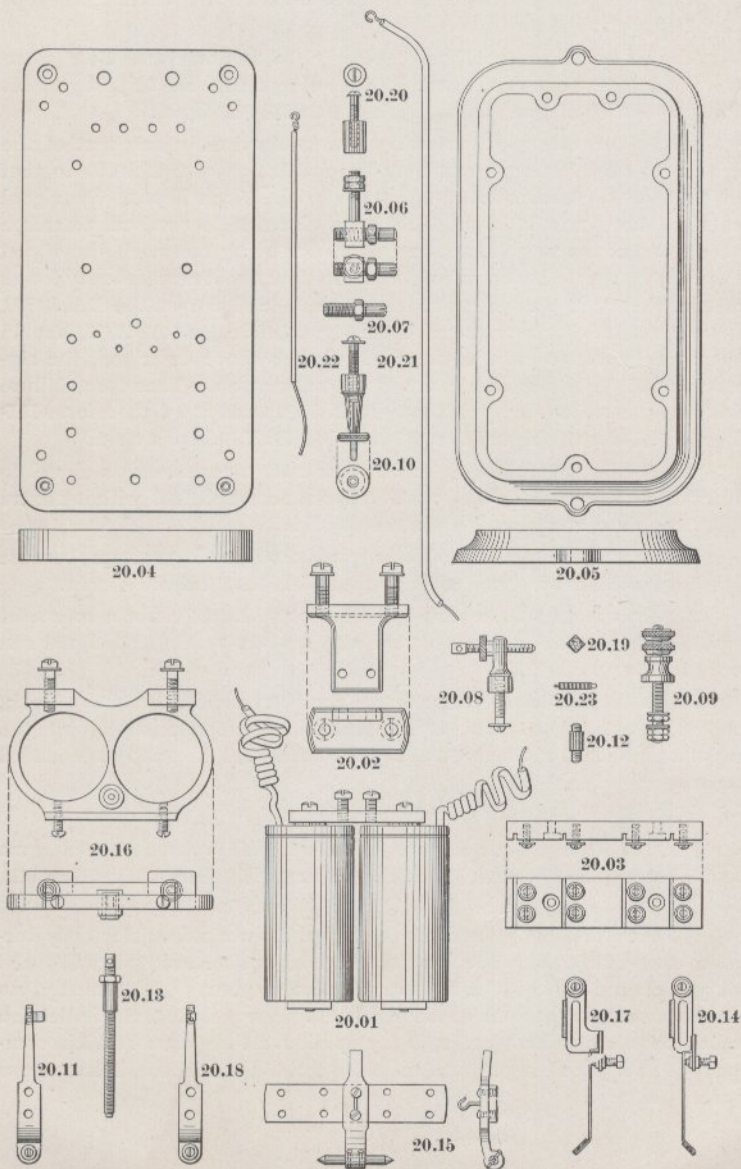

Order No.	ELECTRICAL INSTRUMENTS, RELAYS. Section 20.	Price.
20.00	Standard Relay, complete (give number and kind of contacts).....	\$25.00
20.01	Magnet (give resistance).....	10.00
20.02	Magnet Stand.....	.75
20.03	Spring Bar.....	.75
20.04	Slate Base, drilled.....	.75
20.05	Iron Base.....	.30
20.06	Brass Foot for pivot shaft, with washers and nuts...	.25
20.07	Pivot Screw, with lock nut.....	.10
20.08	Back Stop Post, complete, with screw and washer...	.50
20.09	Standard Binding Post, complete, with nut and washer	.25
20.10	Tension Post, complete, with top, screw and washer	.25
20.11	Aluminum Finger, front (state kind of contact).....	
	Notched Platinum.....	1.00
	Angle Platinum.....	1.00
20.12	Bone Armature Insulations.....	.10
20.13	Front Stop Screw, with brass tube and nut.....	.15
20.14	Front Spring, complete (state kind of contact).....	
	Split Platinum.....	1.00
	Silver Carbon.....	1.00
20.15	Armature and Lever, with shaft.....	1.00
20.16	Yoke, with rubber bushing and screws.....	.75
20.17	Back Spring, complete (state kind of contact).....	1.00
20.18	Aluminum Finger, back (state kind of contact).....	1.00
20.19	Brass Nut for armature insulations.....	.01
20.20	Brass Feet, with washers and nuts.....	.05
20.21	Insulated Connecting Wire for springs.....	.03
20.22	Connecting Wires, with rubber tubing for fingers...	.03
20.23	Tension Springs.....	.02
20.24	<b>Testing Relay</b> , complete.....	5.00
20.25	Testing Relay Magnets, with large adjusting nuts...	2.00
20.26	Testing Relay Yoke.....	.80
20.27	Testing Relay Magnet Stand and Base, with screws	.80
20.28	Armature, with lever and shaft.....	.75
20.29	Back Stop Post, complete.....	.25
20.30	Base.....	.25
20.31	Binding Posts, old style.....	.10
20.32	Wrench for springs.....	.25
20.33	Wrench for front stop.....	.25

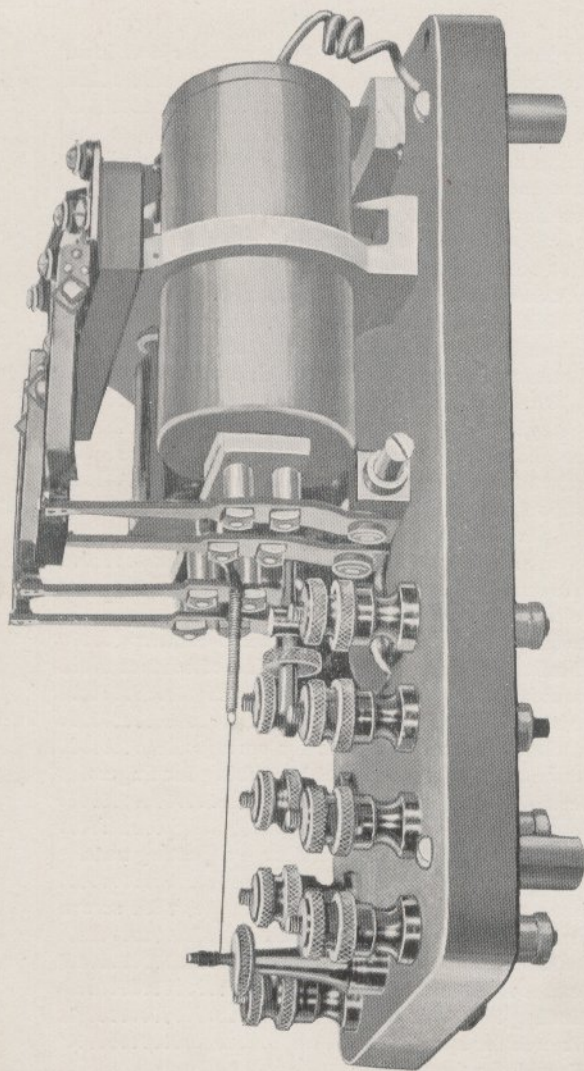

Standard Relay.



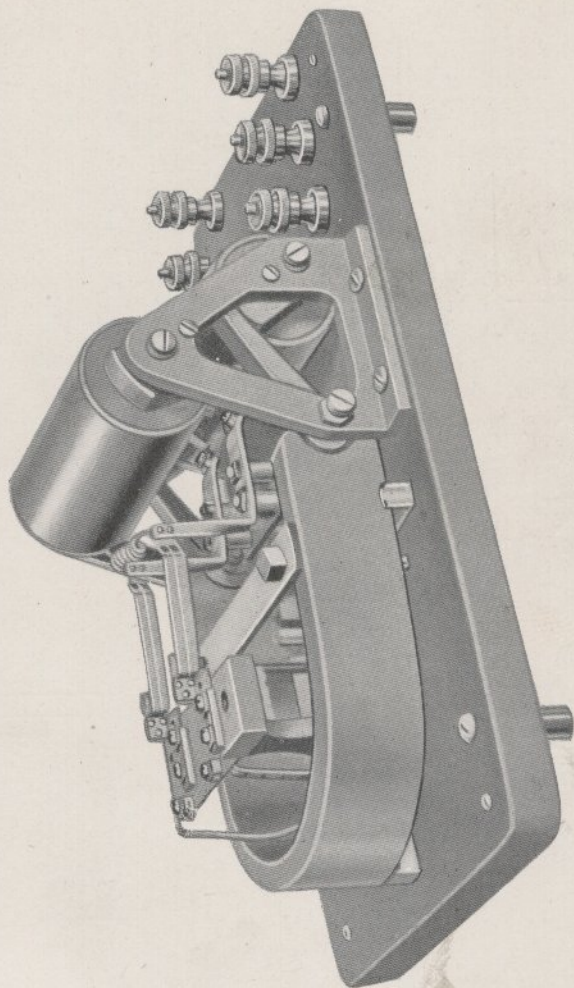

Polarized Relay.

### Polarized Relay.

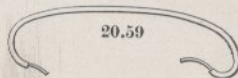
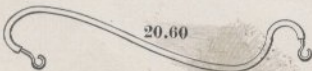
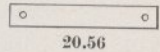
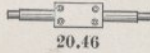
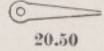
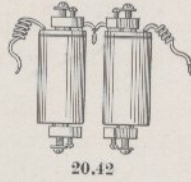
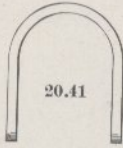
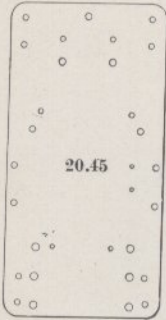

Order No.	<b>Section 20, Relays—Continued.</b>	Price.
20.40	Polarized Relay.....	\$25.00
20.41	Permanent Steel Magnet.....	3.00
20.42	Set Electro Magnets, with screw and washer.....	10.00
20.43	Brass Magnet Stand, left hand.....	.50
20.44	Brass Magnet Stand, right hand.....	.50
20.45	Slate Base.....	.75
20.46	Combined Pivot Shaft and Plate.....	.35
20.47	Composition Stand, with screws.....	.40
20.48	Brass Base Screws for brass stand, each.....	.05
20.49	Special Steel Bearing Screw, with lock nut.....	.10
20.50	Armature, each.....	.50
20.51	Bone Armature Insulations.....	.10
20.52	Brass Nuts for Armature Insulations, each.....	.01
20.53	Aluminum Fingers, complete.....	1.00
20.54	Spring Bar, with screws.....	.75
20.55	Front Spring, complete.....	1.00
20.56	Brass Plate.....	.25
20.57	Round Head Screws, with nuts.....	.10
20.58	Binding Posts, complete.....	.25
20.59	Wires, with rubber tubing.....	.03
20.60	Okonite Wires.....	.03
20.61	Round Brass Feet.....	.10
20.62	Slotted Brass Feet, with nuts.....	.10

# Double Circuit Instrument.

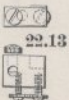
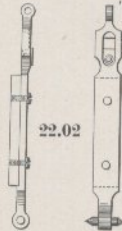
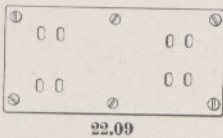
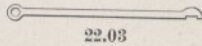
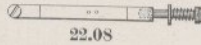
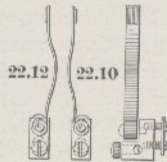
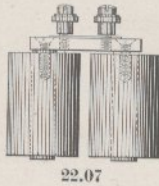
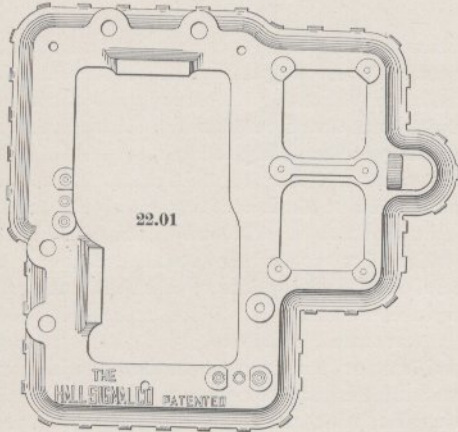

Order No.	<b>DOUBLE CIRCUIT INSTRUMENT.</b>	Price.
	<b>Section 22.</b>	
22.00	Double Circuit Instrument, complete .....	\$20.00
22.01	Frame.....	3.00
22.02	Lower Magnet Armature.....	1.00
22.03	Upper Magnet Armature.....	1.00
22.04	Armature Bearings.....	.50
22.05	Armature Bearings.....	.50
22.06	Adjustable Screws .....	.10
22.07	Magnet.....	5.00
22.08	Spring Bar.....	.75
22.09	Base.....	.50
22.10	Back Spring.....	2.00
22.11	Spring Contact Plate.....	.50
22.12	Front-Contact Spring.....	2.00
22.13	Spring Contact Plate.....	.50
22.14	Binding Post, with bushing and screws .....	.25

## Single Track Interlocking Relay.

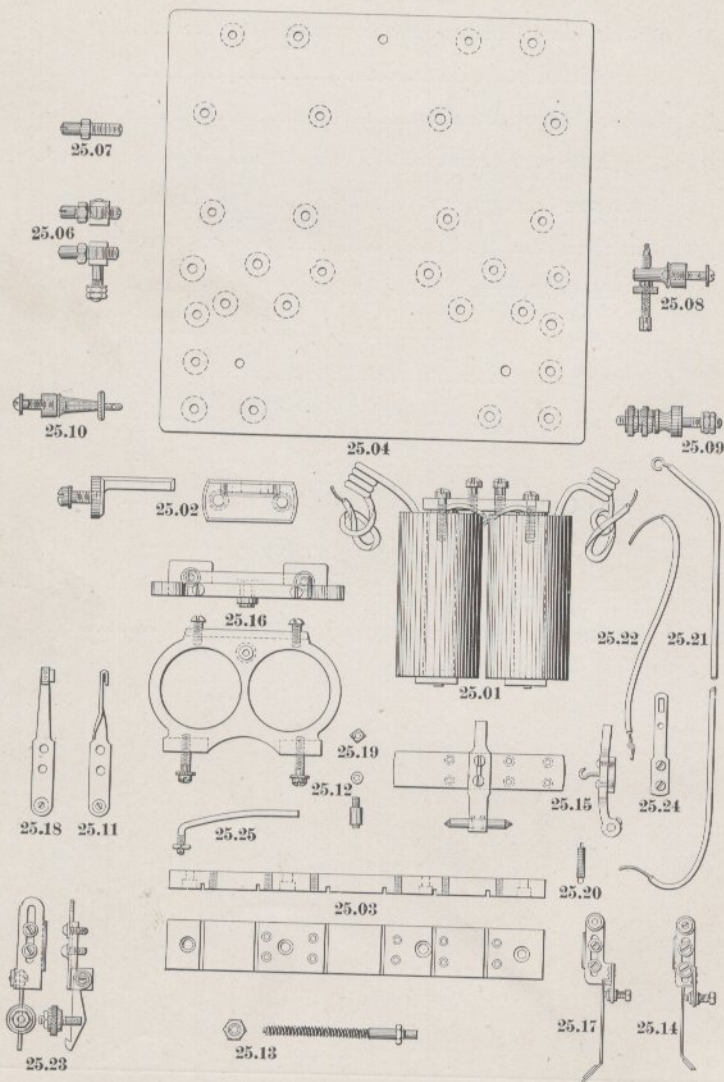

Order No	SINGLE TRACK INTERLOCKING RELAY.	Price.
	<b>Section 25.</b>	
25.00	Interlocking Relay, complete (give number of circuits).....	\$50.00
25.01	Magnets.....	10.00
25.02	Magnet Stand.....	.75
25.03	Spring Bar, special.....	1.00
25.04	Slate Base, 9" x 9" x $\frac{3}{4}$ ".....	1.00
25.06	Brass Foot for armature shaft.....	.25
25.07	Pivot Screws, with lock nuts, for armature shaft....	.10
25.08	Back Stop Post, complete.....	.25
25.09	Standard Binding Post, complete, with hex. nuts...	.25
25.10	Tension Post, complete, with top.....	.25
25.11	Aluminum Finger, front (notched platinum).....	1.00
	(Angle platinum or silver).....	1.00
25.12	Armature Insulation.....	.10
25.13	Front Stop Screw, with brass tube and nut.....	.15
25.14	Front Spring, complete (split platinum) state kind	1.00
	(Silver carbon).....	1.00
25.15	Armature and Lever, with shaft.....	1.00
25.16	Yoke, with rubber bushing and screws.....	.75
25.17	Back Spring, complete (split platinum).....	1.00
	(Silver carbon).....	1.00
25.18	Aluminum Finger, back (state kind of contact) notched platinum, angle platinum or silver, each.....	1.00
25.19	Brass Nut for armature insulation.....	.01
25.20	Tension Spring.....	.02
25.21	Insulated Connecting Wires for springs.....	.02
25.22	Connecting Wires with rubber tubing for fingers...	.02
25.23	Special Anvil, with brass latch. complete, with brass counterweight.....	1.25
25.24	Brass Locking Fingers, each.....	.35
25.25	Brass Wire Arms, each.....	.10

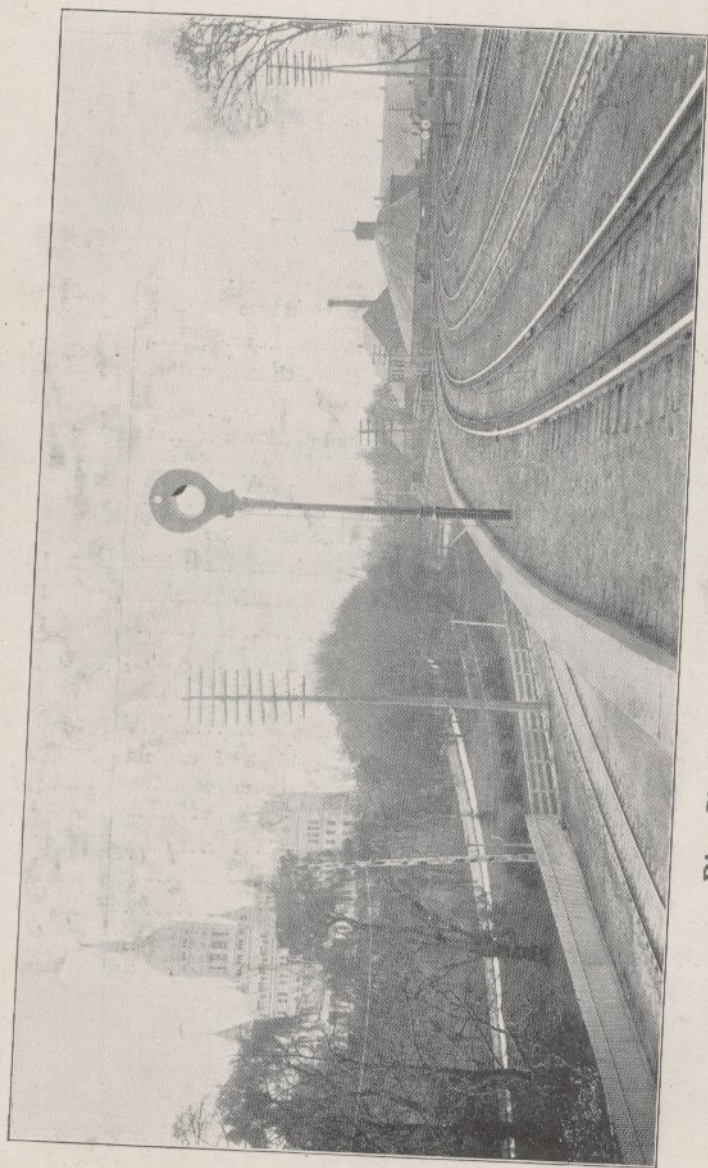

Disc Signals on the N. Y. N. H. & H. R. R.



Single Track Interlocking Relay.

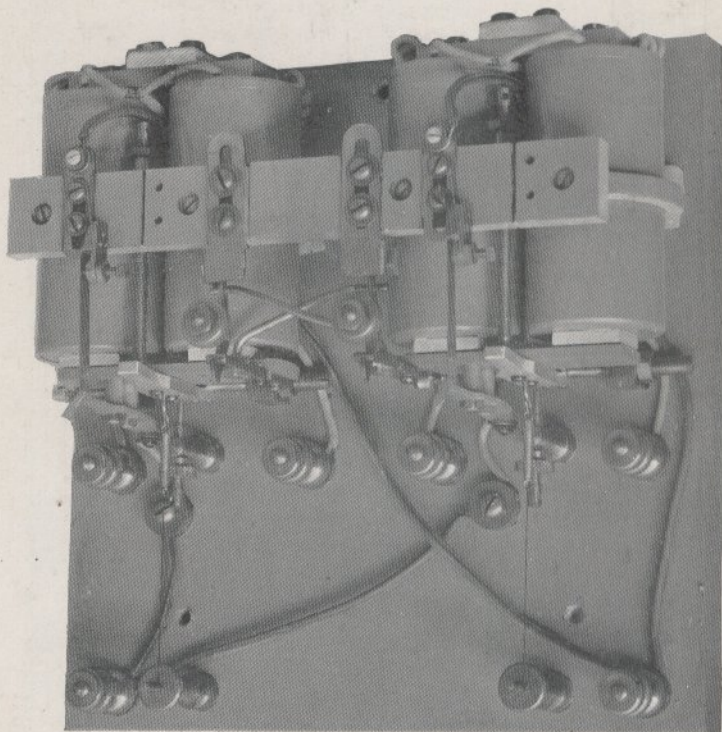

# Switch Lock, Style A.

27.11



THE HALL SIGNAL CO

NEW YORK  
& CHICAGO

27.02

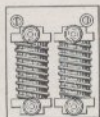

27.13

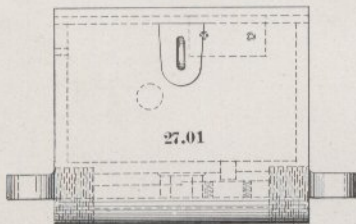

27.01

27.04

27.05



27.06



27.07

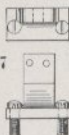

27.08

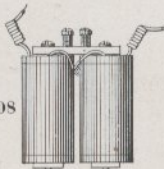

27.03

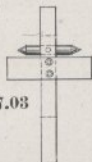

27.10



27.09

27.12

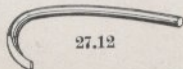

Order No.	SWITCH LOCK.	Price.
	<b>Section 27. Style A.</b>	
27.00	Switch Lock, complete, with rods, lugs, bolts, lags and Lock.....	\$25.00
27.01	Box Casting.....	5 00
27.02	Box Cover, with hasp.....	1.50
27.03	Latch, with armature and pivot shaft.....	1.50
27.04	Brass Glands.....	1.10
27.05	Grooved Rod.....	2.50
27.06	Connecting Rod.....	2.00
27.07	Magnet Stand.....	.35
27.08	Magnet (give resistance).....	10.00
27.09	Pivot Stand.....	.15
27.10	Pivot Screws, with nuts.....	.15
27.11	Hasp.....	.15
27.12	Asbestos Packing.....	.05
27.13	Lightning Arrester, Style E, two point.....	1.50

# Electric Switch Lock, Style B.

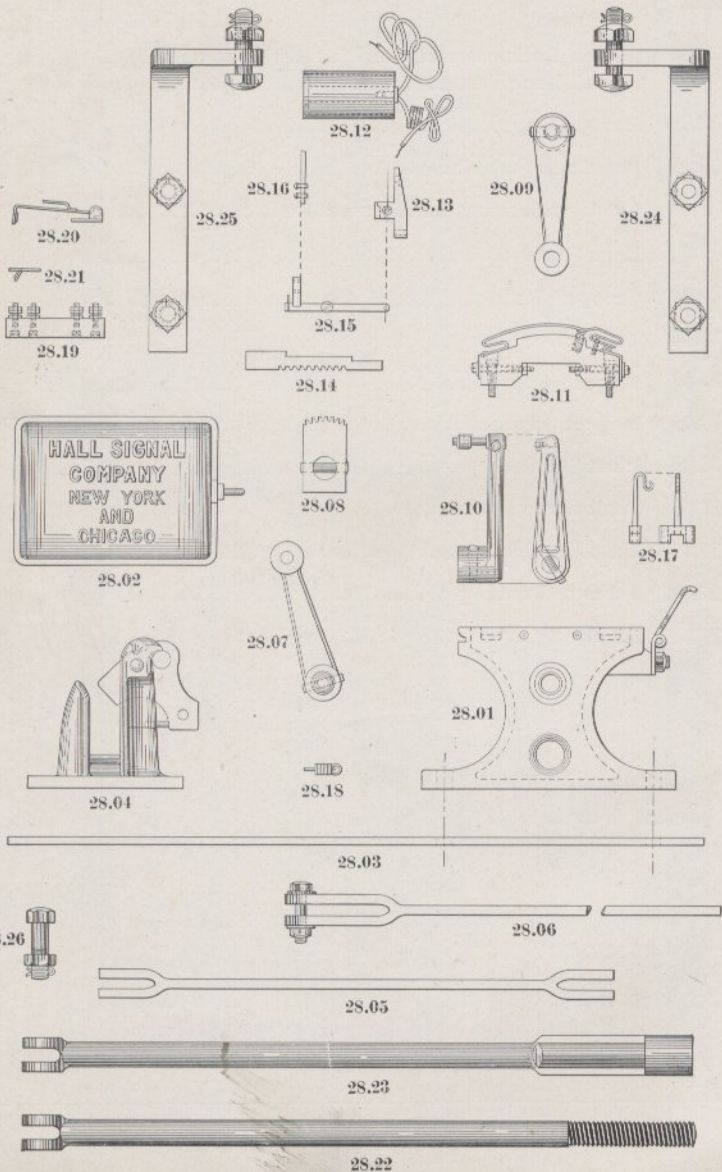



## Electric Slot.

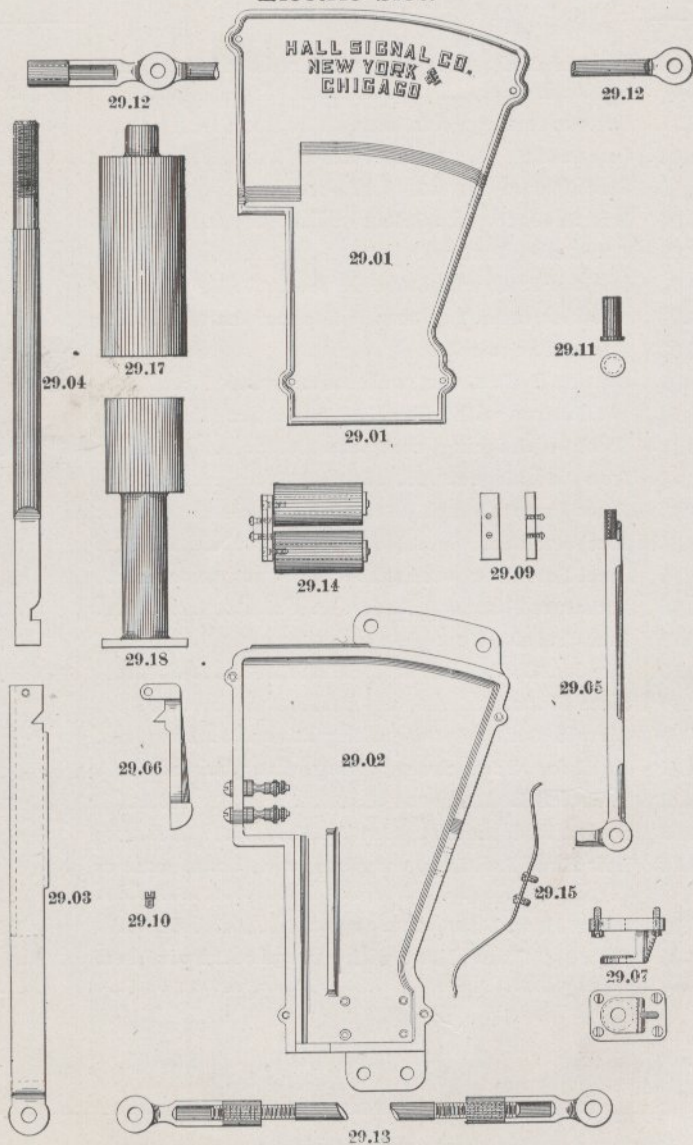

Order No.	ELECTRIC SLOT. Section 29.	Price.
29.00	Electric Slot, complete.....	\$50.00
29.01	Box Cover.....	2.00
29.02	Box, with binding post and bushings.....	8.00
29.03	Lower Rod.....	2.25
29.04	Upper Rod.....	4.00
29.05	Armature Lever.....	2.00
29.06	Tooth Lever.....	1.50
29.07	Armature Lever Bearing.....	.75
29.08	Jam Nut.....	.10
29.09	Armature.....	.75
29.10	Tooth Lever Screws, each.....	.05
29.11	Pin.....	.25
29.12	Upper Connecting Rod.....	3.50
29.13	Lower Connecting Rod.....	3.50
29.14	Magnets, with brass plate and screws.....	10.00
29.15	Spring.....	.25
29.16	Clevis Nut for upper rod 29.04.....	.75
29.17	Cylinder for dash pot.....	6.00
29.18	Plunger for dash pot.....	3.50
29.19	Binding Post, complete.....	.25
29.20	Long Fibre Bushings for wires, each.....	.05
29.21	$\frac{3}{8}$ " No. 14-24 fil. head, brass screws, each.....	.02
29.22	$\frac{7}{8}$ " No. 14-24 fil. head, brass screws, each.....	.02
29.23	$\frac{1}{2}$ " x 4" Lag Screws, each.....	.05
29.24	Clevis Nut, with pipe thread.....	.75

## Electric Bells.

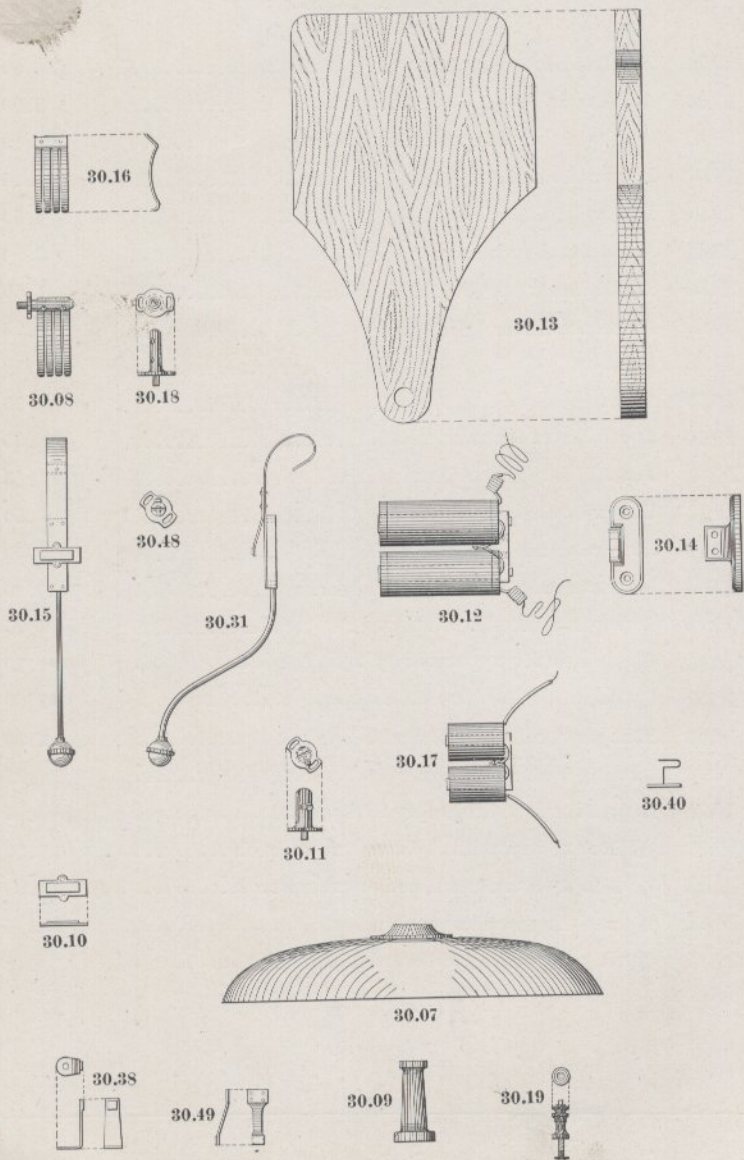



Order No.	ELECTRIC BELLS. Section 30.	Price.
30.00	Vibrating Bell, comb spring, 14" gong.....	\$18.00
	Vibrating Bell, comb spring, 5" gong.....	10.00
30.07	Gong only, for 14" bell.....	7.00
	Gong only, for 5" bell.....	1.00
30.08	Comb Spring, with post for 14" bell.....	2.25
	Comb Spring, with post for 5" bell.....	1.75
30.09	Gong Post for 14" bell.....	.10
	Gong Post for 5" bell.....	.10
30.10	Spring Plate, with platinum contact, for 14" bell....	1.75
30.11	Striker Post (state whether for comb spring or straight spring, and size of gong).....	
	14" Gong.....	.35
	5" Gong.....	.25
30.12	Magnets for 14" bells.....	5.00
30.13	Base for 14" bell.....	.60
	Base for 5" bell.....	.50
30.14	Magnet Stand for 14" bell.....	.30
	Magnet Stand for 5" bell.....	.20
30.15	Striker, complete, for comb spring bell, 14" bell....	2.75
	Striker, complete, for comb spring bell, 5" bell....	2.00
30.16	Comb Spring only, with platinum contact for 14" bell	2.00
	Comb Spring only, with platinum contact for 5" bell	1.50
30.17	Magnets for 5" bell (give resistance).....	3.00
30.18	Comb Spring Post only for 14" bell.....	.35
	Comb Spring Post only for 5" bell.....	.25
30.19	Binding Post, complete.....	.25
30.20	Stroke Bell, complete, for indicator board (state size, etc.).....	5.00
30.21	Vibrating Bell, complete, for indicator board (state size, etc.).....	6.00
30.30	Vibrating Bell, complete, straight spring, 14" gong.	16.00
30.31	Striker, complete, for straight spring, 14" bell.....	2.75
30.38	Contact Spring only, with platinum contact for 14" bell.....	1.00
30.40	Guide for striker, for 14" bell.....	.10
30.48	Contact Spring Post for 14" straight spring bell....	.35
30.49	Striker Spring, with platinum contact for 14" bell..	1.00

# Lever Lock for National Machine.

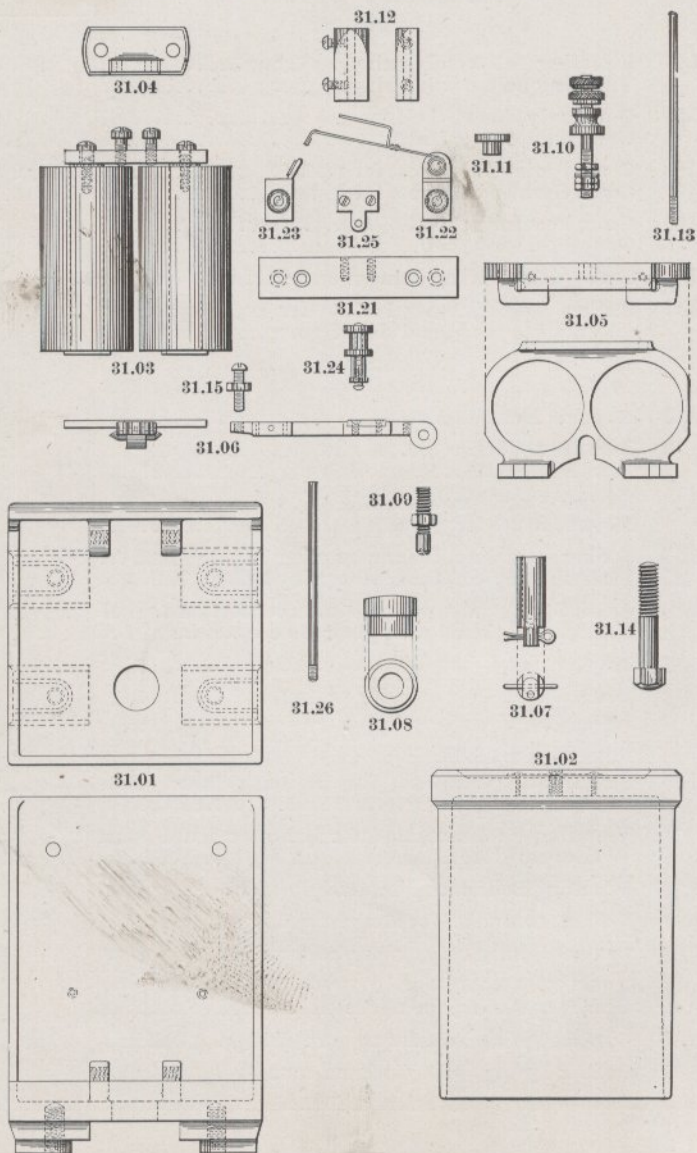

Order No.	LEVER LOCKS.	Price.
<b>Section 31.</b>		
31.00	Lever Lock, complete, for National Machine.....	\$25.00
31.01	Bottom Casting, with composition bushing.....	4.35
31.02	Cover Casting.....	2.00
31.03	Magnets (state resistance).....	10.00
31.04	Magnet Stand.....	.35
31.05	Yoke.....	1.00
31.06	Lever, with shaft and armature.....	1.00
31.07	Steel Plunger.....	.20
31.08	Composition Bushing.....	.50
31.09	Pivot Screw, with lock nut.....	.10
31.10	Standard Binding Post, complete, with hex. nuts...	.25
31.11	Fibre Bushing.....	.05
31.12	Brass Counterweight.....	.20
31.13	Counterweight Arm.....	.15
31.14	$\frac{5}{16}$ " x $2\frac{1}{16}$ " Hexagon Head Bolts.....	.10
31.15	Stop Screw and Nut.....	.02
31.16	.....	
31.17	.....	
31.18	.....	
31.19	.....	
31.20	Lever Lock, complete, with circuit closer, National Machine.....	25.50
31.21	Spring Bar.....	.50
31.22	Circuit Closing Spring, with screws and nuts.....	2.00
31.23	Anvil, with screws and nuts.....	.50
31.24	Insulation Roller, complete, with shaft and set screw.....	1.25
31.25	Brass Guide Plate, with screws.....	.25
31.26	Plunger Stem.....	.50

## Lever Lock for Union Machine.

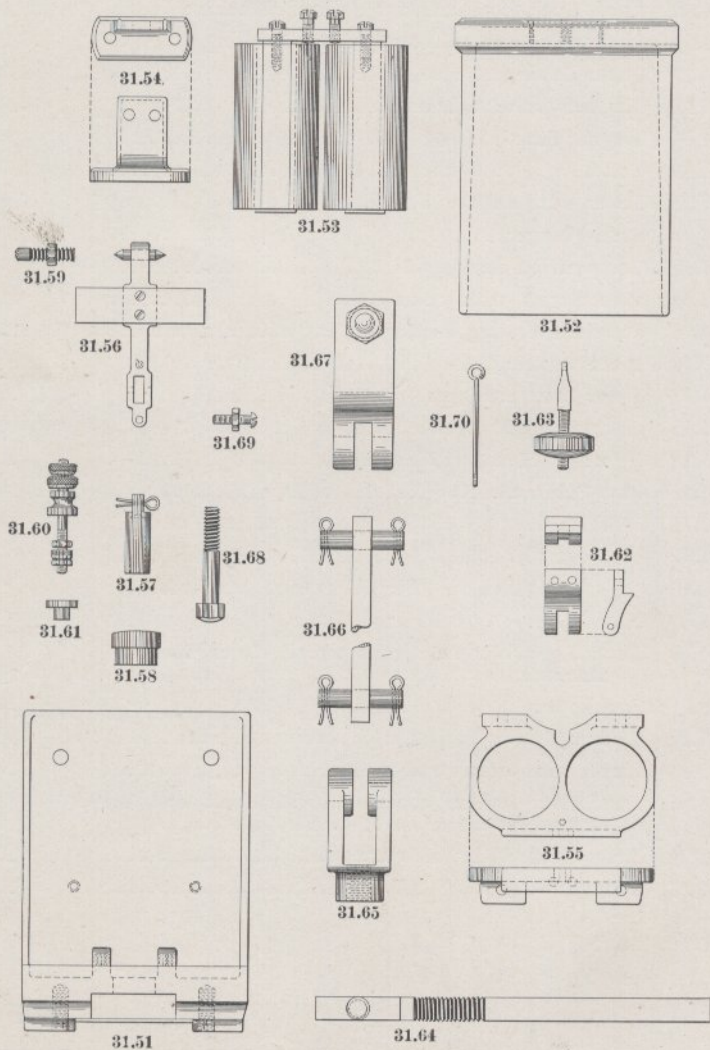

Order No.	<b>LEVER LOCKS.</b>	Price.
<b>Section 31.</b>		
31.50	Lever Lock, complete, for Union Machine.....	\$25.00
31.51	Bottom Casting only, with brass plate.....	5.00
31.52	Cover .....	2.00
31.53	Magnets, complete (state resistance).....	10.00
31.54	Magnet Stand.....	.35
31.55	Yoke.....	1.00
31.56	Composition Lever, with pivot shaft and armature..	2.00
31.57	Steel Plunger.....	.20
31.58	Composition Bushing .....	.50
31.59	Pivot Screws, with lock nuts.....	.10
31.60	Binding Posts, complete, with hexagon nuts.....	.25
31.61	Fibre Bushings, each.....	.05
31.62	Counterweight Stand.....	.15
31.63	Counterweight Arm, with iron counterweight.....	.50
31.64	Locking Bar.....	2.00
31.65	Turnbuckle.....	1.00
31.66	Connecting Link, with pins.....	.90
31.67	Clamp, complete, with bolt .....	1.50
31.68	$\frac{5}{16}$ " x $2\frac{1}{16}$ " Hexagon Head Bolt.....	.10

# Track Instrument.

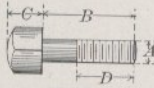

35.58

A	B	C	D	REMARKS.
1	20	1	2 7/8	33, 36, & 40 EX. N.
1	20	1	2 1/4	" " " " " " " "
3/4	11	3/4	2	" " " " " " " "
3/4	9	3/4	2	" " " " " " " "
3/4	11	3/4	1 1/2	" " " " " " " "
1/2	2 1/2	3/4	1 1/4	EX. FINISH.
1/2	2 5/8	3/4	1 1/4	" " " " " "

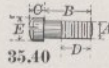

35.40

A	B	C	D	E	REMARKS.
3/8	1	3/8	5/8	1/2	FINISHED.
1/4	1 1/2	3/8	5/8	1 1/2	" "

Order No.	TRACK INSTRUMENTS.	Price.
<b>Section 35.</b>		
35.00	Track Instrument, complete, unmounted (give length of lever).....	\$75.00
35.01	Chair.....	4.00
35.02	Large Rubber Spring.....	5.00
35.03	Small Rubber Spring.....	2.50
35.04	Bonnet.....	2.50
35.05	Inside Buffer Plate.....	.25
35.06	Cup Washer for fulcrum pin.....	.10
35.07	Spindle.....	8.00
35.08	Lever, 38", 45" or 48".....	15.00
35.09	Fulcrum Pin.....	1.00
35.10	Split Key for fulcrum pin.....	.02
35.11	Yoke.....	.75
35.12	Column.....	20.00
35.13	Cap for pipe.....	.15
35.14	Top Plate.....	4.00
35.15	Saucer for large spring.....	.20
35.16	Plate for small spring.....	.20
35.17	Channel Iron.....	.20
35.18	Dust Guard Spring.....	.25
35.19	Dust Guard.....	.50
35.20	.....	
35.21	.....	
35.22	Pipe.....	.40
35.23	Rail Plate.....	.20
35.24	Square Nut Lock.....	.02
35.25	Hexagon Nut Lock.....	.02
35.26	Spring Block.....	.25

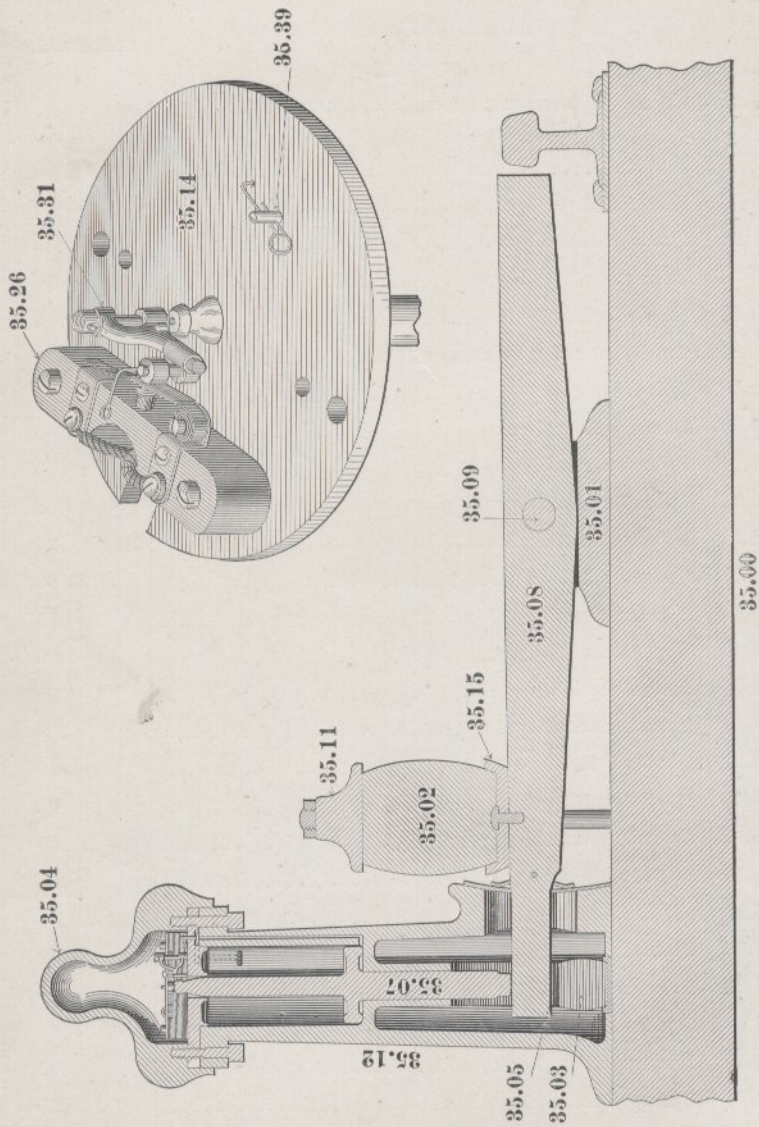

Track Instrument.



Order No.	Section 35—Continued.	Price.
35.27	Top Plate Spring Holder.....	\$0.15
35.28	Contact Plate for closed spring.....	.50
35.29	Contact Plate for two open springs.....	.60
35.30	Top Plate Spring Holder, two springs on one block..	.20
35.31	Swinging Arm.....	1.00
35.32	Swinging Arm for two springs.....	1.00
35.33	Swinging Arm Pin.....	.05
35.34	Top Plate Pin.....	.05
35.35	Top Plate Pin.....	.05
35.36	Guard for spring.....	.05
35.37	Valve Spring.....	.05
35.38	Bolts for rubber spring, 1" x 22"—1" sq. hd. hx. nut	.25
	Bolts for column, $\frac{3}{4}$ " x 11"— $\frac{3}{4}$ " sq. hd. hx. nut.....	.10
	Bolts for chair, $\frac{3}{4}$ " x 11"— $\frac{3}{4}$ " sq. hd. hx. nut.....	.15
	Bolts for bonnet, $\frac{1}{2}$ " x 2"— $\frac{11}{16}$ "— $\frac{3}{4}$ " hx. hd.....	.10
	Bolts for pipe cap, $\frac{1}{2}$ " x 2"— $\frac{3}{4}$ " hx. hd. fin.....	.10
35.39	Valve, with screw.....	.15
35.40	Screws for top plate, $\frac{3}{8}$ " x 1"— $\frac{5}{16}$ " round head fin...	.05
	Screws for spring block, $\frac{1}{4}$ " x 1 $\frac{1}{2}$ "— $\frac{7}{32}$ " round hd. fin.	.05
35.41	Open Spring.....	1.35
35.42	Closed Spring.....	1.35
35.43	Contact Plate for open springs, two springs on one block.....	.70
35.44	Contact Plate for closed springs, two springs on one block.....	.70
35.45	Disc for column base.....	.30
35.46	Wrench.....	.50
35.47	Track Instrument, complete, mounted on timber 8" x 12" x 11'.....	80.00

## Switch Instrument.

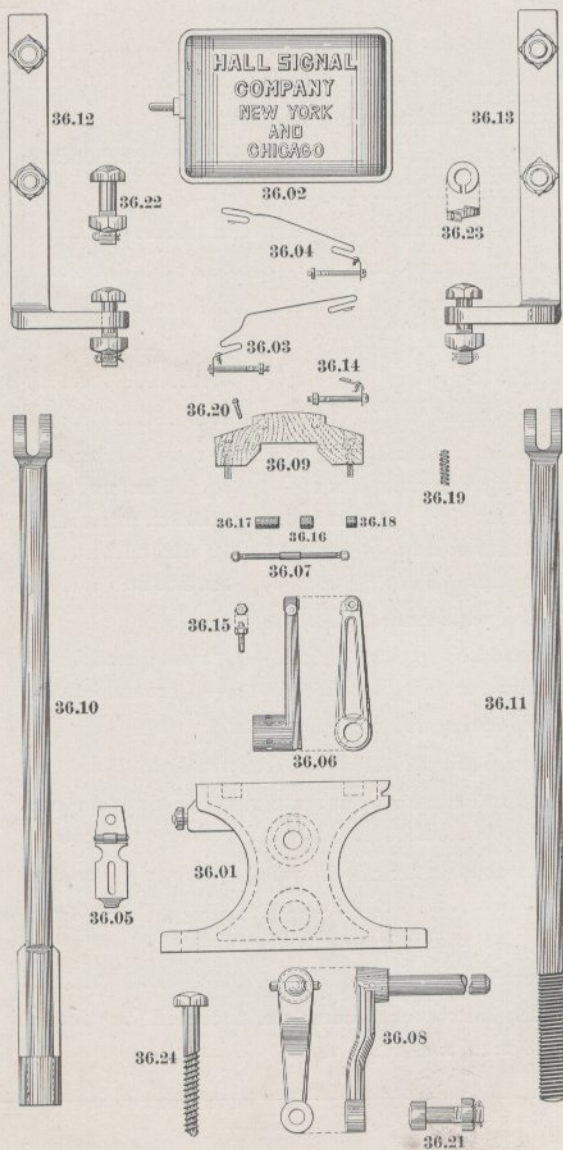

Order No.	SWITCH INSTRUMENTS.	Price.
<b>Section 36.</b>		
36.00	Switch Instrument, complete with rods, lugs, bolts, lags and locks (state whether right or left hand lug) .....	\$25.00
36.01	Base Casting .....	5.50
36.02	Cover .....	2.50
36.03	Open Spring, with screws .....	2.00
36.04	Closed Spring, with screws .....	2.00
36.05	Hasp .....	.15
36.06	Inside Arm .....	1.00
36.07	Roller Shaft and Nuts (state if for 2 or 4 rollers) .....	.50
36.08	Main Shaft and Outside Arm .....	1.50
36.09	Spring Block, with screws .....	.75
36.10	Socket Rod .....	2.00
36.11	Threaded Rod .....	1.50
36.12	Left Hand Rail Lug, complete with bolts .....	1.00
36.13	Right Hand Rail Lug, complete with bolts .....	1.00
36.14	Spring Anvil, with screw .....	.50
36.15	Lock Bolt and Nut .....	.05
36.16	Insulated Roller .....	.25
36.17	Sleeve .....	.05
36.18	Insulation .....	.05
36.19	Spiral Spring .....	.02
36.20	Slot Screw .....	.03
36.21	$\frac{5}{8}$ " x $2\frac{1}{4}$ " Turned Bolts, with nut and cotter pin .....	.10
36.22	$\frac{5}{8}$ " x $2\frac{1}{2}$ " Rough Bolts, with nut and cotter pin .....	.10
36.23	Spring Washers .....	.02
36.24	$\frac{3}{16}$ " x 5" Lags .....	.05

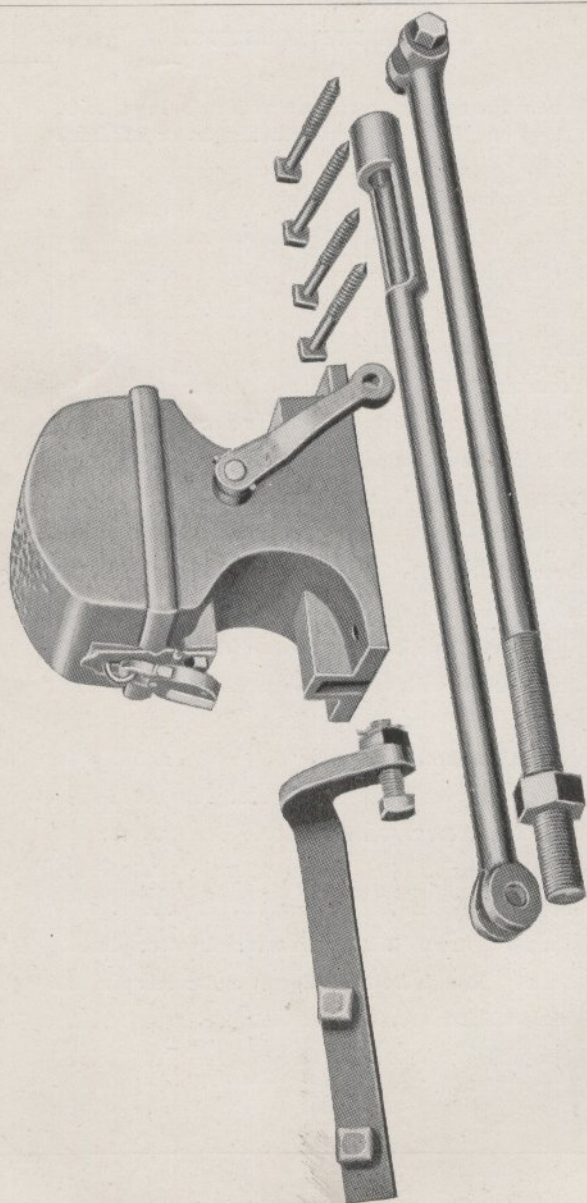

Switch Instrument.

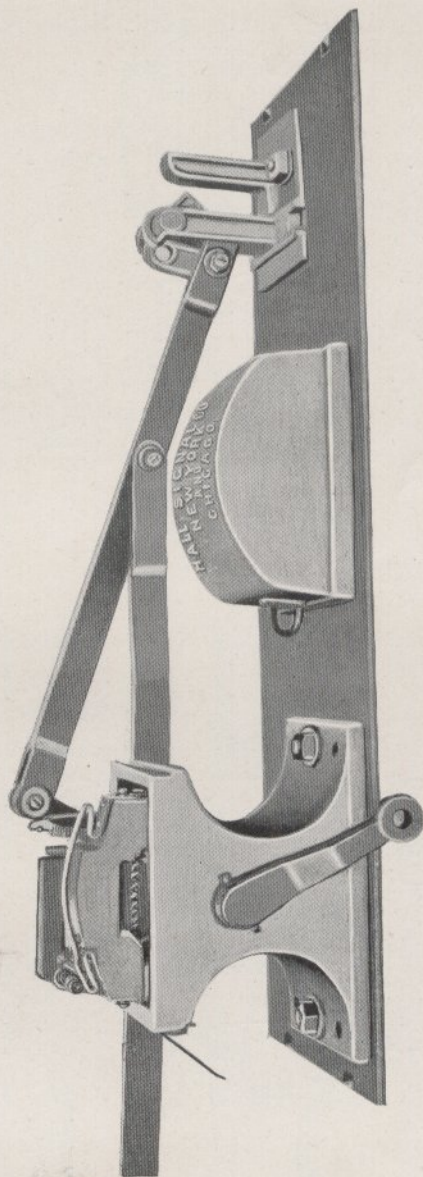

Electric Switch Lock, Style B.

## Commutator Instrument, Style A.



36.02



37.21

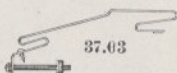

37.03

37.20

37.19



37.09



37.14

37.17 37.16 37.18



37.07

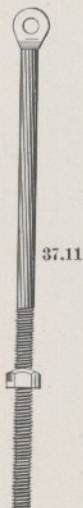

37.11



37.15

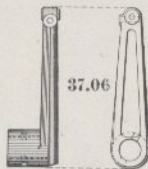

37.06

37.10

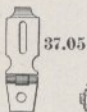

37.05

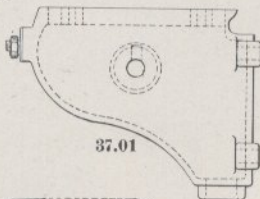

37.01

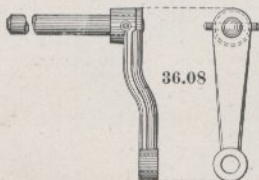

36.08



37.22



## Commutator Instrument, Style B.

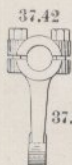
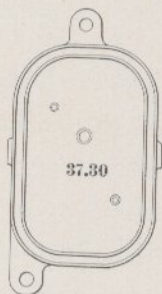
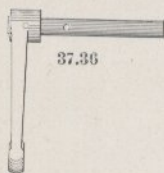

37.41

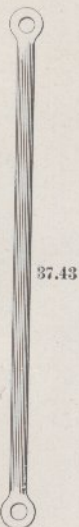
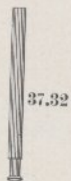
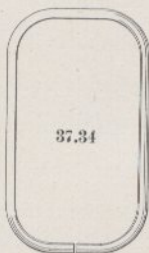
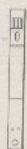



Order No.	<b>COMMUTATORS.</b>	Price.
	<b>Section 37.</b>	
	<b>Style B.</b>	
37.20	Slot Screw.....	\$ .03
37.25	Commutator, complete (give number of springs)....	15.00
37.30	Box Casting.....	2.00
37.31	Cover Casting.....	.75
37.32	Stud Bolt.....	.10
37.33	Nut and Hasp.....	.25
37.34	Rubber Tubing.....	.30
37.35	Steel Pin for shaft.....	.02
37.36	Crank Arm, with shaft.....	.75
37.37	Cam, complete.....	.50
37.38	Brass Spring Block.....	.10
37.39	Spring, with screws.....	2.00
37.40	Anvil, with screws.....	.50
37.41	Clamp for rod.....	.50
37.42	Half Clamp, with bolts.....	.50
37.43	Commutator Rod.....	1.00
37.44	Stud Bolt and Nut.....	.25
37.45	Wood Block, with screws.....	.30
37.46	$\frac{1}{2}$ " x $3\frac{1}{2}$ " Lags, each.....	.05

## Bell Frames.

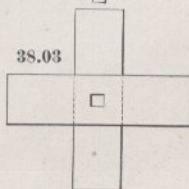
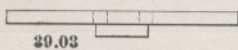
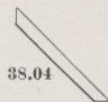
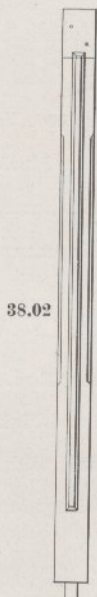
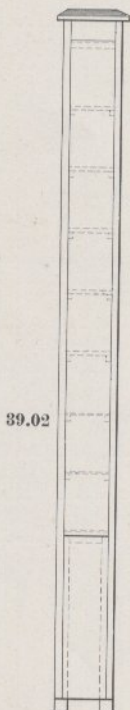
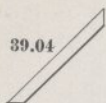
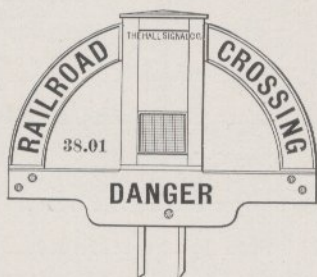
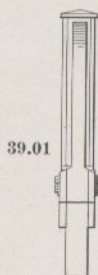

Order No.	<b>BELL FRAMES, SOLID POST.</b>	Price.
<b>Section 38.</b>		
38.00	Frame, complete, with solid post.....	\$40.00
38.01	Frame, complete.....	24.00
38.02	Post, complete.....	15.00
38.03	Bottom Cross Pieces (2).....	1.50
38.04	Bottom Braces (4).....	1.00
<b>BELL FRAMES, HOLLOW POST.</b>		
<b>Section 39.</b>		
39.00	Frame, complete, with hollow post.....	50.00
39.01	Frame, complete.....	26.00
39.02	Hollow Post.....	20.00
39.03	Bottom Cross Pieces (2).....	1.50
39.04	Bottom Braces (4).....	1.00

### Disc Signal Fittings Wood Post.

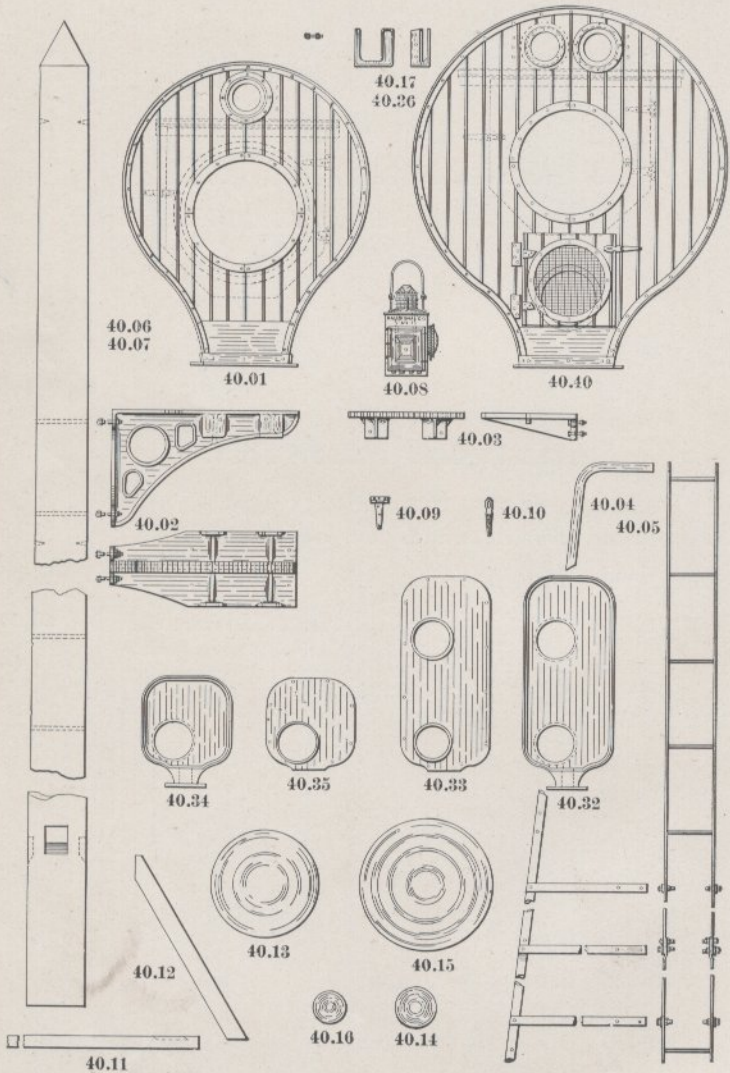

Order No.	DISC SIGNAL FITTINGS.	Price.
<b>Section 40.</b>		
40.01	Standard Signal Case .....	\$45.00
40.02	Bracket, with bolts .....	6.00
40.03	Platform, with bolts .....	5.00
40.04	28 foot Iron Ladder, with bolts and braces .....	8.00
40.05	32 foot Iron Ladder, with bolts and braces .....	9.00
40.06	32 foot Yellow Pine Post, complete, with crosses and braces .....	10.00
40.07	37 foot Yellow Pine Post, complete, with crosses and braces .....	14.00
40.08	Standard No. 7 Lamp .....	3.00
40.09	Hinges for signal case .....	.10
40.10	Hasp for signal case .....	.10
40.11	Crosses for bottom of pole .....	1.50
40.12	Braces for bottom of pole .....	1.00
40.13	Large Front Glass for signal cases, 18 $\frac{3}{4}$ " .....	.75
40.14	Small Front Glass for signal cases, 7" .....	.15
40.15	Large Back Glass for signal cases, 22 $\frac{3}{4}$ ", painted ...	.85
40.16	Small Back Glass for signal cases, 5" .....	.15
40.17	Lamp Bracket .....	.35
40.18	.....	
40.19	.....	
40.20	.....	
40.21	.....	
40.22	.....	
40.23	.....	

## Special Signal Cases.

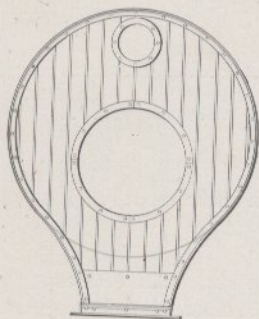

40.01

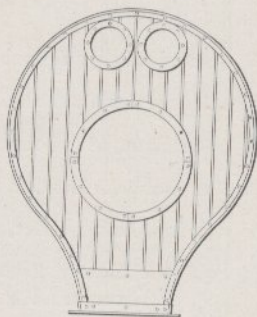

40.11

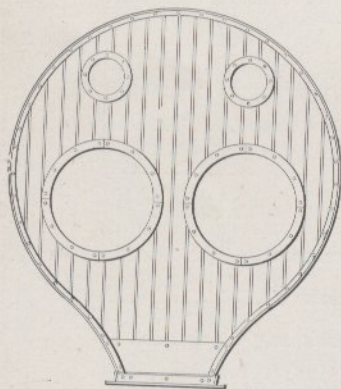

40.44

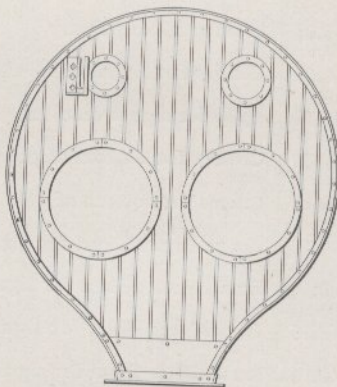

40.43



40.30



40.31

Order No.	<b>Section 40—Continued.</b>	Price.
40.24	.....	
40.25	.....	
40.26	.....	
40.27	.....	
40.28	.....	
40.29	.....	
40.30	Special Iron Signal Case for two signals, print 449A	\$35.00
40.31	Special Iron Signal Case for one signal, print 449A.	30.00
40.32	Casting for two signal case.....	25.00
40.33	Cover for two signal case.....	10.00
40.34	Castings for one signal case.....	22.00
40.35	Cover for one signal case.....	8.00
40.36	Lamp Bracket.....	.35
40.37	.....	
40.38	.....	
40.39	.....	
40.40	Case for combination signal and bell.....	55.00
40.41	Case for C. & N. W. distant signal.....	50.50
40.42	.....	
40.43	Double Disc Case for opposite direction.....	50.00
40.44	Double Disc Case for same direction.....	50.00

### Disc Signals Complete, Wood Posts.

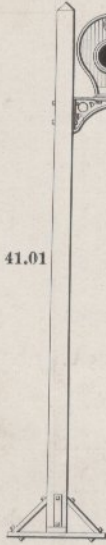

41.01

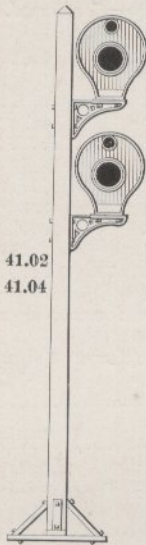

41.02  
41.04

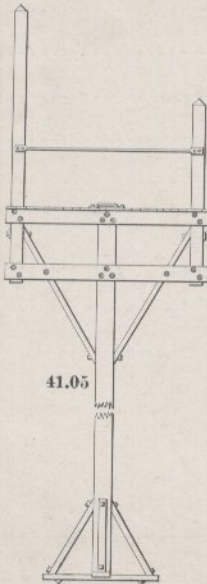
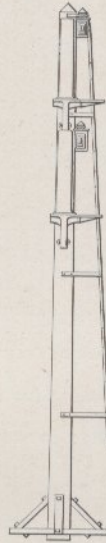

41.05

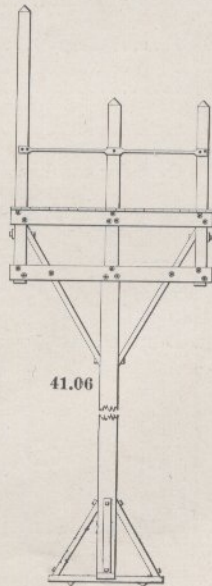

41.06



Order No.	<b>DISC SIGNALS, COMPLETE WITH WOOD POST.</b>	Price.
<b>Section 41.</b>		
41.01	32 foot Yellow Pine Post, complete, with one signal case, ladder, lamp and lock .....	\$65.00
41.02	32 foot Yellow Pine Post, complete, with two signal cases, lamps, locks and ladder.....	110.00
41.03	.....	
41.04	37 foot Yellow Pine Post, complete, with two signals, complete .....	115.00
41.05	Two Doll Bracket Signal Pole.....	65.00
41.06	Three Doll Bracket Signal Pole .....	75.00

### Iron Poles for Disc Signals.

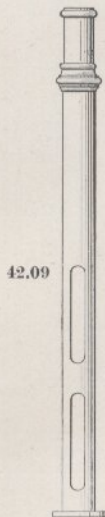
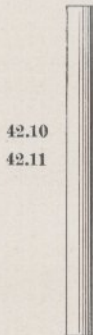
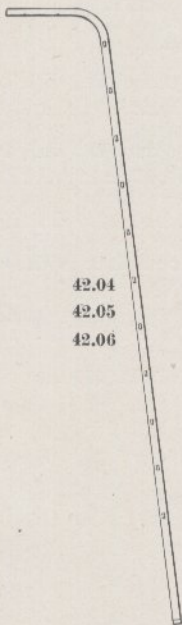
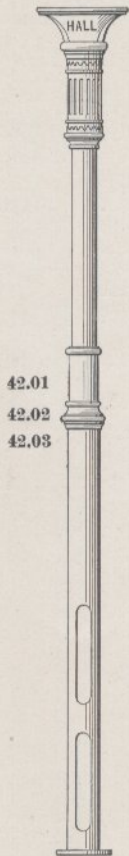

Order No.	<b>IRON POLES FOR DISC SIGNALS.</b>	Price.
<b>Section 42.</b>		
42.01	Fifteen foot Iron Post .....	\$28.00
42.02	Twenty foot Iron Post .....	32.00
42.03	Twenty-five foot Iron Post .....	37.00
42.04	Ladder for 15 foot iron pole, 11' long .....	4.00
42.05	Ladder for 20 foot iron pole, 16' long .....	4.50
42.06	Ladder for 25 foot iron pole, 21' long .....	5.50
42.07	Braces, for 20 and 25 foot iron poles .....	2.00
42.08	Top Casting .....	10.00
42.09	Bottom Casting .....	12.00
42.10	Center Pipe, for 20 foot pole, 10' long .....	10.00
42.11	Center Pipe, for 25 foot pole, 15' long .....	15.00
<b>IRON POLES, COMPLETE, FOR DISC SIGNALS.</b>		
<b>Section 42.</b>		
42.15	Fifteen foot Iron Pole, complete, with ladder .....	30.00
42.16	Twenty foot Iron Pole, complete, with ladder and braces .....	35.00
42.17	Twenty-five foot Iron Pole, complete, with ladder and braces .....	40.00

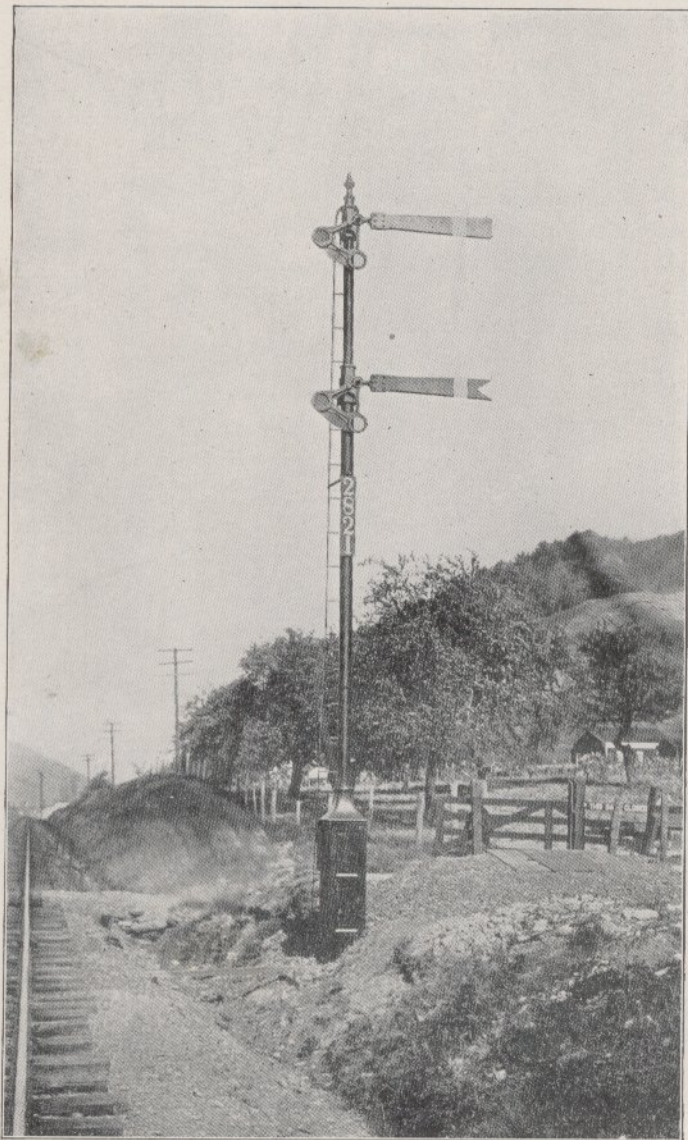

Order No.	IRON POLE SEMAPHORE FITTINGS.	Price.
<b>Section 44.</b>		
44.01	Acron Top Casting, iron.....	\$ 2.00
44.02	Casting for top arm, iron.....	5.25
44.03	Casting for bottom arm, iron.....	5.75
44.04	Hand Hole Plate, iron.....	.25
44.05	Screws for same, brass, each.....	.05
44.06	Weather Plate. front end shaft, iron.....	.15
44.07	Arm Casting for single arm pole, 5" pipe.....	5.25
44.08	Gasket for weather plate, each.....	.10
44.09	Screws for weather plate.....	.02
44.10	Oil Cup.....	.15
44.11	Home Blade Shaft.....	2.50
44.12	Distant Blade Shaft.....	2.50
44.13	Nut for shaft.....	.15
44.14	Washer for shaft.....	.01
44.15	Crank Arm for shaft, right hand.....	.50
44.16	Crank Arm for shaft.....	.50
44.17	Filler for top arm.....	.05
44.18	Lamp Bracket, top arm, (home).....	.50
44.19	Lamp Bracket, bottom arm, (distant).....	.50
44.20	Ladder for single signal.....	7.00
44.21	Bolts for top of ladder, each.....	.05
44.23	Bolts for ladder braces. $\frac{1}{2}$ " x 2", each.....	.05
44.24	Ladder for double signal.....	8.00
44.25	Top Brace for ladder.....	1.00
44.26	Bottom Brace for ladder.....	1.00
44.27	Iron Shelf.....	1.25
44.28	Top Section Pipe, 4" x 6'.....	3.50
44.29	Bottom Section Pipe, 5" x 16'.....	11.00
44.30	Pipe for single signal pole.....	14.00

**Electric Semaphore Signals on Lehigh Valley R. R.**

Order No.	IRON POLE SEMAPHORE FITTINGS.	Price.
<b>Section 44.</b>		
44.31	Steel Attachment for safety light.....	\$1.50
44.32	.....	
44.33	.....	
44.34	.....	
44.35	Spectacle Casting, two-light .....	5.50
44.36	Spectacle, single light .....	3.25
44.37	Bolts for glass circle, single light, each.....	.05
44.38	Circle for safety light, on two-light spectacle.....	.50
44.39	Circle for danger glass, on two-light spectacle.....	.30
44.40	Back Light Casting.....	1.50
44.41	Stud and nuts for same.....	.50
44.42	.....	
44.43	Circle for back light glass .....	.50
44.44	Bolts for back light casting.....	.05
44.45	Spectacle Casting, two-light, 90° .....	5.50
44.46	Circle for glass.....	
44.47	Straight Crank Arm for 50°.....	.50
44.48	Lamp Bracket, home signal, 90°.....	.50
44.49	Lamp Bracket, distant signal, 90° .....	.50
44.50	Sectional Clamp Bearing.....	3.00
44.51	Sectional Clamp Bearing.....	3.00
44.52	.....	
44.53	Brass Circle.....	.50
44.54	Rod for locking lever, front door .....	.50
44.55	Cam for locking rod, each .....	.15
44.56	.....	
44.57	Locking Lever for motor box, front door .....	.25
44.58	.....	
44.59	Steel Shaft for clamp bearing.....	2.50
44.60	Box Casting, complete.....	35.00
44.61	Base Casting.....	10.00
44.62	Top Casting of box, with bolts, for double signal...	7.50

## Electric Semaphore Signals on Chicago & Alton R. R.





Order No.	Section 44—Continued.	Price.
44.63	Left Hand Side of Box, for double signal . . . . .	\$5.50
44.64	Right Hand Side of Box, for double signal . . . . .	5.50
44.65	Back of Box for double signal . . . . .	5.50
44.66	Bottom of Box for double signal (with bolts) . . . . .	6.50
44.67	Iron Door, Front of Box, for double signal . . . . .	6.00
44.68	Washers for clamp bearings. . . . .	.05
44.69	. . . . .	
44.70	Back Door of Box for double signal . . . . .	2.00
44.71	Locking Lever for back door of double signal . . . . .	.25
44.72	Locking Rod for back door of double signal . . . . .	.25
44.73	. . . . .	
44.74	Bolts for blades, each . . . . .	.05
44.75	Home Blade . . . . .	1.15
44.76	Distant Blade . . . . .	1.15
44.77	Red Glass, $6\frac{7}{8}$ " diameter . . . . .	.25
44.78	Green Glass, $6\frac{7}{8}$ " diameter . . . . .	.50
44.79	Yellow Glass, $6\frac{7}{8}$ " diameter . . . . .	.75
44.80	Complete, Up and Down Rod . . . . .	5.00
44.81	Clevis Nut . . . . .	.75
44.82	Coupling, (state size) . . . . .	.10
44.83	Turnbuckle . . . . .	1.50
44.84	One half inch Lock Nut . . . . .	.02
44.85	Upper Section of Rod . . . . .	3.50
44.86	Lower Section of Rod . . . . .	1.50
44.87	Wood Guide for rod in top pipe . . . . .	.15
44.88	Wood Guide for rod in bottom pipe . . . . .	.15
44.89	Special Circle, L. U. R. R. . . . .	.75
44.A	Single Blade Post, complete (no motor) . . . . .	100.00
44.B	Single Blade Post, complete (with motor) . . . . .	175.00
44.C	Double Blade Post, complete (no motor) . . . . .	175.00
44.D	Double Blade Post, complete (with motor) . . . . .	300.00

# Wood Pole, Semaphore Signal Fittings.

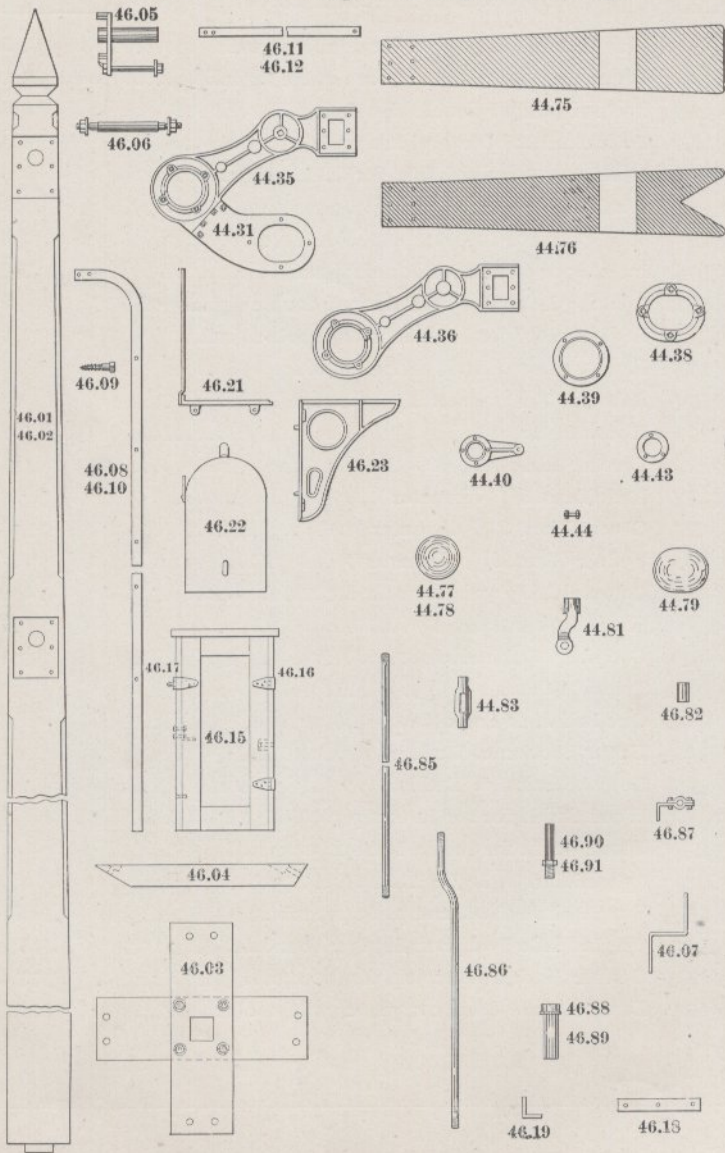

Order No.	WOOD POLE SEMAPHORE FITTINGS. Section 46.	Price.
46.01	Signal Pole for double signal.....	\$10.00
46.02	Signal Pole for single signal.....	10.00
46.03	Crosses for bottom of pole.....	1.50
46.04	Braces for bottom of pole.....	1.00
46.05	Semaphore Bearing, with lag screws.....	6.00
46.06	Shaft for same, with nuts.....	2.50
46.07	Lamp Bracket.....	.35
46.08	Ladder for single signal 28'.....	8.00
46.09	Lag Screws, each.....	.05
46.10	Ladder for double signal 32'.....	9.00
46.11	Top Braces.....	.30
46.12	Lower Brace.....	.35
46.13	.....	
46.14	.....	
46.15	Wooden Motor Box, complete.....	10.00
46.16	Hinges.....	.15
46.17	Hasp.....	.15
46.18	Wooden Shelf.....	.50
46.19	Angle Iron Supports, for motor.....	.50
46.20	Iron Box for Signal, complete (short con.).....	10.00
46.21	Motor Platform, with steel side.....	6.00
46.22	Cover.....	2.00
46.23	Bracket, with bolts.....	10.00
46.24	.....	
46.25	.....	
46.26	.....	
46.27	.....	
46.28	.....	
46.29	.....	
46.30	.....	
46.31	Steel Bracket for safety light.....	3.00
46.32	.....	
46.33	.....	

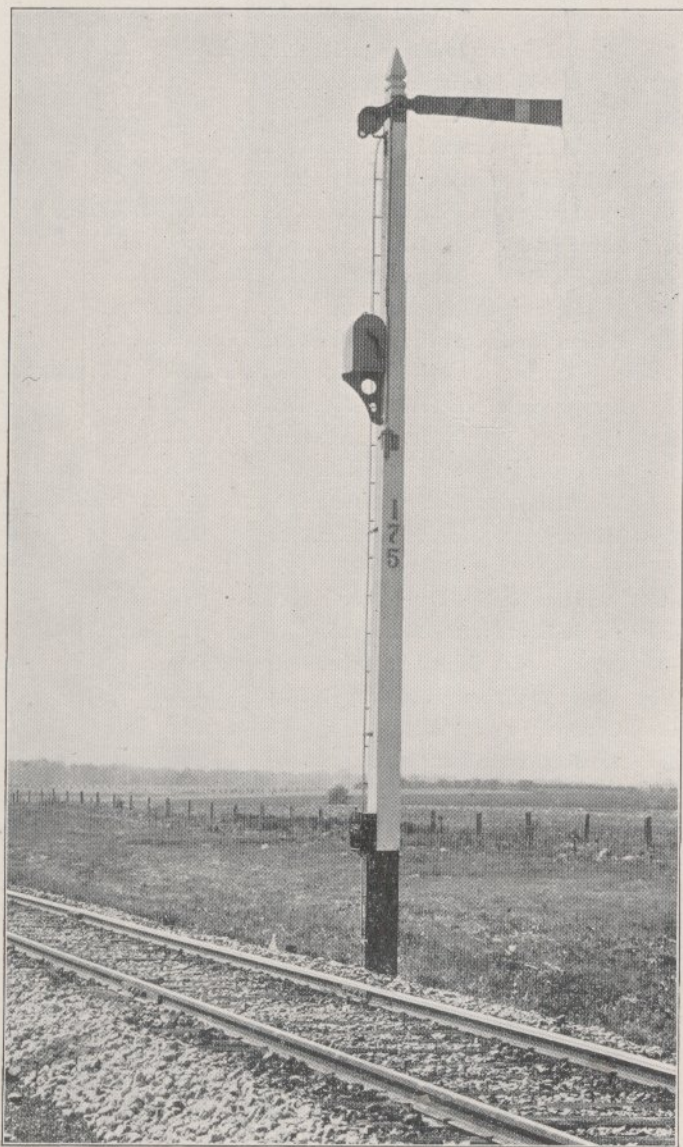
**Electric Signals on Illinois Central R. R.**

Order No.	Section 46—Continued.	Price.
46.34	.....	
44.35	Blade Grip, two light.....	\$5.50
44.36	Blade Grip, one light.....	3.25
46.37	.....	
44.38	Circle for clear light.....	.50
44.39	Circle for danger light.....	.30
44.40	Back Light Casting.....	1.50
44.41	Stud for same.....	.50
46.42	.....	
44.43	Circle for back light castings.....	.50
44.44	Bolts for back light castings.....	.05
46.45	.....	
46.46	.....	
46.47	.....	
46.48	.....	
46.49	.....	
46.50	.....	
46.51	.....	
46.52	.....	
46.53	.....	
46.54	.....	
46.55	.....	
46.56	.....	
46.57	.....	
46.58	.....	
46.59	.....	
46.60	.....	
46.61	.....	
46.62	.....	
46.63	.....	
46.64	.....	
46.65	.....	

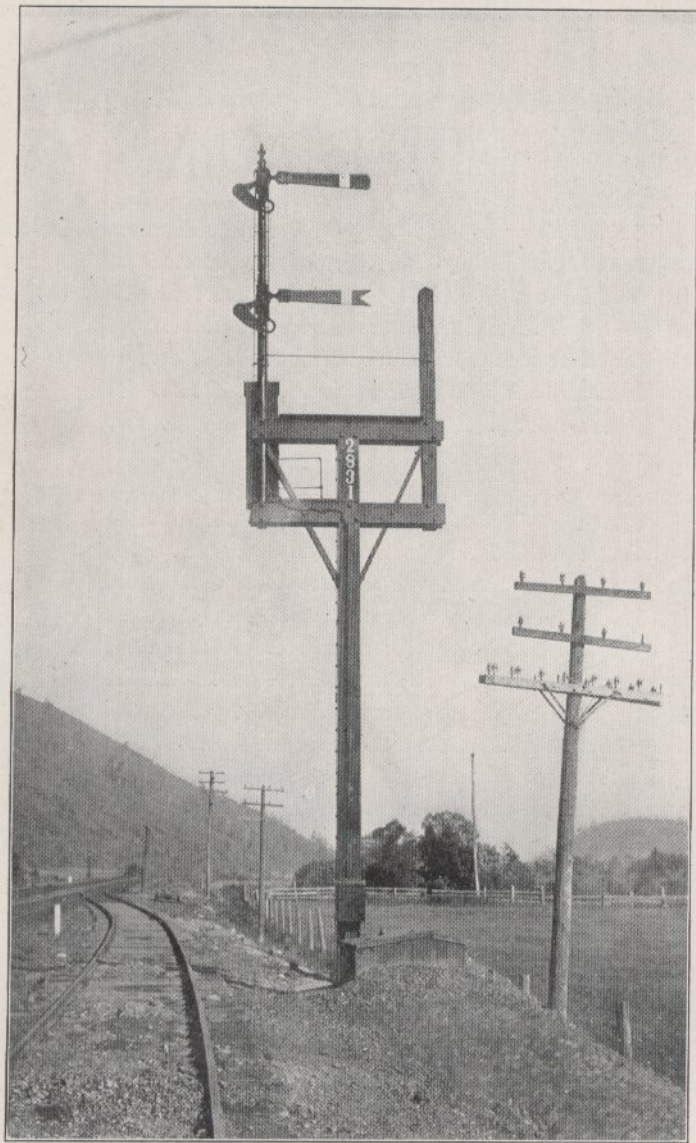
**Electric Semaphore Signals on Lehigh Valley R. R.**

Order No.	<b>Section 46—Continued.</b>	Price.
46.66	.....	
46.67	.....	
46.68	.....	
46.69	.....	
46.70	.....	
46.71	.....	
46.72	.....	
46.73	.....	
46.74	.....	
44.75	Home Blade .....	\$1.15
44.76	Distant Blade .....	1.15
44.77	Red Glass 6 $\frac{7}{8}$ " .....	.25
44.78	Green Glass 6 $\frac{7}{8}$ " .....	.50
44.79	Yellow Glass .....	.75
46.80	.....	
44.81	Clevis Nut .....	.50
46.82	Coupling (state size) .....	.15
44.83	Turnbuckle for $\frac{1}{2}$ " pipe .....	1.50
46.85	Top Section Up and Down Rod .....	3.50
46.86	Lower Section Up and Down Rod .....	1.50
46.87	Clamp Guide for up and down rod .....	.50
46.88	Cap 1 $\frac{1}{2}$ " for rain guard .....	.50
46.89	Pipe 1 $\frac{1}{2}$ " for same .....	.30
46.90	Pipe 1" for same .....	.25
46.91	Lock Nuts (1") .....	.10







### Wood Pole Semaphore Signals.

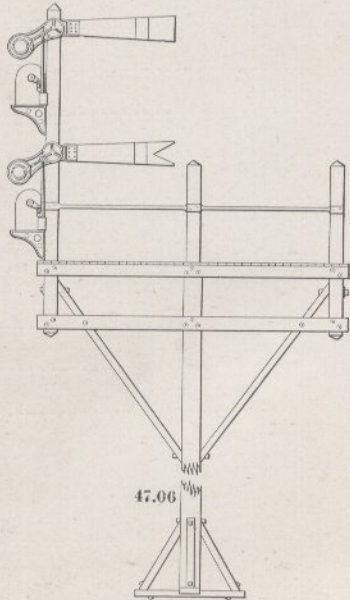
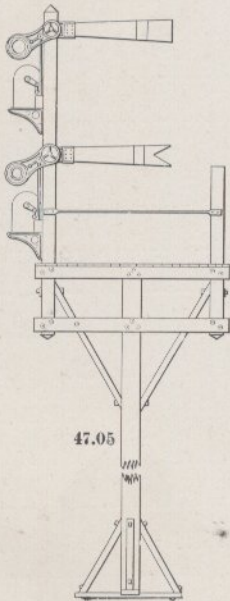
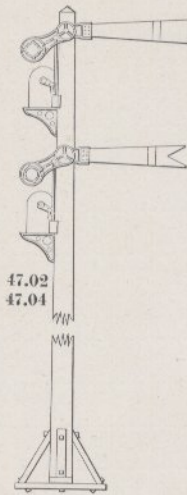
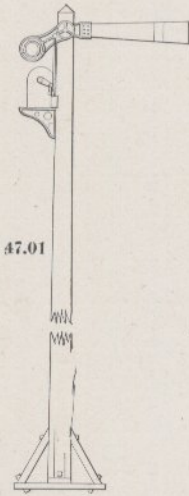

Order No.	<b>SEMAPHORE SIGNALS, COMPLETE, WOOD POLES.</b> Section 47.	Price.
47.01	One Blade Signal, complete. ....	\$150.00
47.02	Two Blade Signal, complete. 32 foot post. ....	275.00
47.03	.....	
47.04	Two Blade Signal, complete, 36 foot post. ....	280.00
47.05	Two-Doll Bracket Post, complete. ....	330.00
47.06	Three-Doll Bracket Post, complete. ....	350.00





### Battery Receptacles.

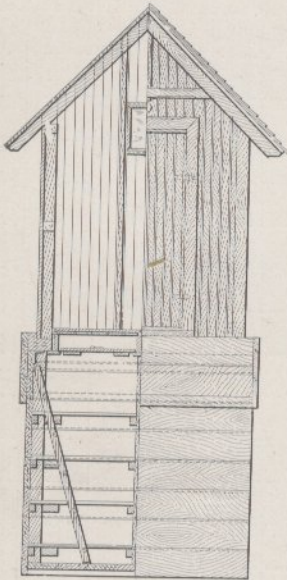

50.03

50.18



50.11



50.16



50.10



50.15



50.12



50.15

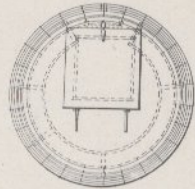

50.01

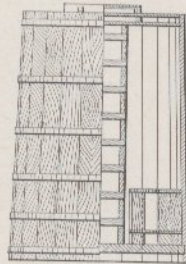

50.08



50.04

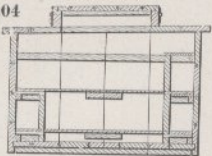

50.02

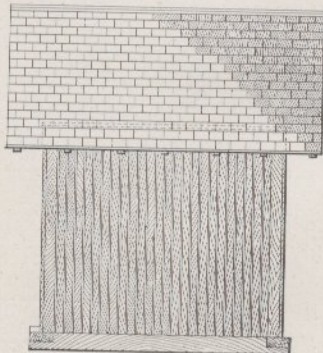

Order No.	<b>BATTERY RECEPTACLES.</b>	Price.
<b>Section 50.</b>		
50.01	Battery Tub (wood).....	\$40.00
50.02	Battery House, ceiled and filled.....	100.00
50.03	Battery House, with wood cellar 5" x 5" x 7".....	100.00
50.04	Battery Box 5" x 5" x 3".....	35.00
50.05	Iron Battery Chute, with 2 cell elevator and lock....	15.00
50.06	Iron Battery Chute, with 3 cell elevator and lock....	15.00
50.07	Iron Battery Chute, with 4 cell elevator and lock....	<del>15</del> .50
50.08	Elevator.....	.75
50.09	.....	
50.10	Pipe Casting for 2 cell battery chute.....	14.00
50.11	Cover Casting, with hasp for same.....	1.25
50.12	Bottom Casting for same.....	1.00
50.13	.....	
50.14	Iron Battery Chute for 4 cells.....	26.00
50.15	Pipe Casting for 4 cell chute.....	25.00
50.16	Cover, with hasp for same.....	2.00
50.17	.....	
50.18	Hasp only for 2 or 4 cell chute.....	.20
50.19	Battery Well, iron, wood lined.....	140.00
50.20	Battery Well, iron.....	130.00

### Battery Material.

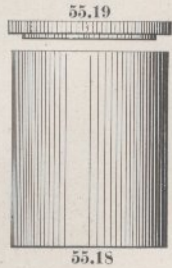
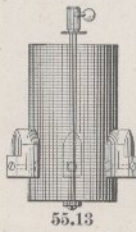
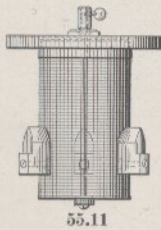
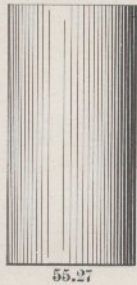
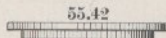
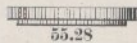
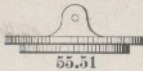
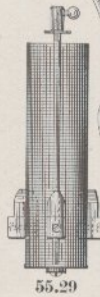
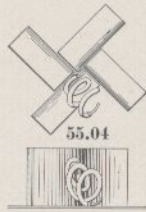
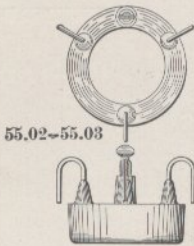

55.22

55.19



Order No.	BATTERY.	Price.
<b>Section 55.</b>		
55.00	Gravity Battery, complete .....	\$1.25
55.01	Glass Jars 6" x 8" .....	.20
55.02	Four pound Mercury Zinc .....	.40
55.03	Four pound Plain Zinc .....	.35
55.04	Copper, Hall Standard. ....	.15
55.05	Blue Vitriol, per pound .....	.10
55.06	Double End Wire Connectors .....	.10
55.10	Gordon Battery No. 1, complete, with glass jar .....	3.00
55.11	Cylinders, complete, with rods, connectors and tin covers .....	<del>77</del>
55.12	Gordon Battery, No. 1, complete, with porcelain jar .....	3.25
55.13	No. 1 Cylinders, complete, with rods and connectors .....	<del>62</del>
55.14	No. 1 Sodium and Oil .....	.30
55.15	No. 1 Copper Element .....	1.00
55.16	No. 1 Renewals, complete .....	1.75
55.17	No. 1 Zinc .....	.45
55.18	No. 1 Porcelain Jars .....	.50
55.19	No. 1 Porcelain Covers .....	.35
55.20	No. 1 Connectors .....	.12
55.21	Tin Covers .....	.15
55.22	.....	
55.25	Gordon Battery No. A, complete, with porcelain jars .....	3.50
55.26	Gordon Renewals No. A .....	1.75
55.27	Porcelain Jars, No. A .....	.65

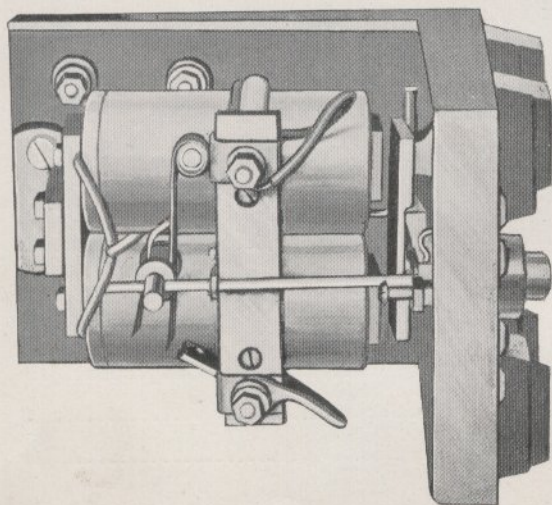
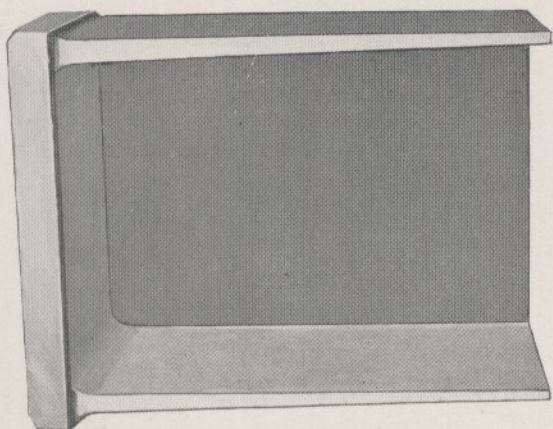

Lever Lock for National Machine.

Order No.	<i>Section 55—Continued.</i>	Price.
55.28	Porcelain Cover, No. A .....	\$0 35
55.29	Perforated Cylinder. for No. A .....	.25
55.30	Zincs for No. A .....	.45
55.35	Edison-Lelande, complete, type R .....	2 90
55.36	Edison-Lelande Renewals, " " .....	1 40
55.37	Two Zinc Plates, " " .....	.50
55.38	One Copper Oxide, " " .....	.55
55.39	One can Potash, " " .....	.28
55.40	Bottle Oil, " " .....	.07
55.41	Porcelain Jar, " " .....	.50
55.42	Porcelain Cover, " " .....	.40
55.45	Edison Battery, complete, type S .....	3 00
55.46	Two Zinc Plates, " " .....	.50
55.47	Two Copper Plates, " " .....	.62
55.48	One can Potash, " " .....	.28
55.49	One bottle Oil, " " .....	.06
55.50	Porcelain Jar, " " .....	.65
55.51	Porcelain Cover, " " .....	.35

## Boxes.



60.21



60.25



60.22



60.24

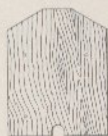

60.23

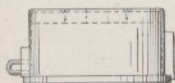

60.03

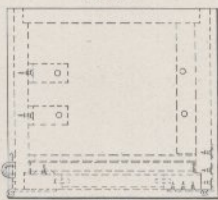

60.15



60.01



60.02

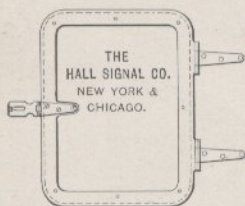

60.04

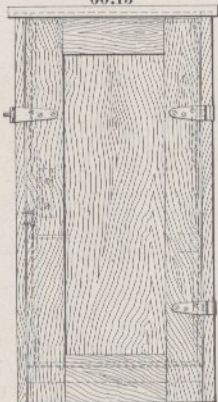

60.10

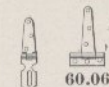

60.05



60.06

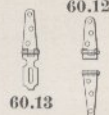

60.12



60.13

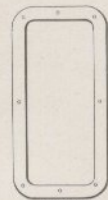

60.07



60.08



60.09

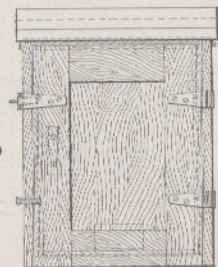

60.11

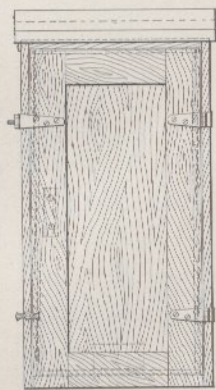

Order No.	<b>BOXES.</b>	Price.
<b>Section 60.</b>		
60.01	Iron Box for one relay or bell.....	\$4.00
60.02	Door for Box for one relay.....	1.20
60.03	Iron Relay Box for two relays.....	4.50
60.04	Door for Box for two relays.....	1.60
60.05	Hasp for iron boxes.....	.10
60.06	Hinges for iron boxes.....	.15
60.07	Gasket for one relay box.....	1.00
60.08	Gasket for two relay box.....	1.10
60.09	Door for iron bell box.....	1.25
60.10	Wood Relay Box for two relays.....	5.00
60.11	Wood Relay Box for four relays.....	6.00
60.12	Hinges.....	.10
60.13	Hasp.....	.10
60.15	Motor Box.....	8.00
60.20	Iron Indicator Box, complete.....	4.00
60.21	Box Casting.....	2.50
60.22	Box Cover.....	1.30
60.23	Box, wooden back.....	.15
60.24	Glass, 4 $\frac{1}{4}$ " x 4 $\frac{1}{2}$ " x $\frac{1}{4}$ ".....	.10
60.25	Frame for glass.....	.10
60.26	Bracket.....	.03
60.27	Rubber Strips. per set.....	.25
60.28	Indicator Boards only (give No. of ind. & bells).....	

## Iron Indicator Box and Post.

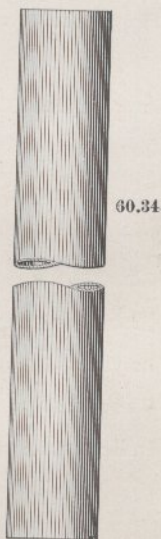
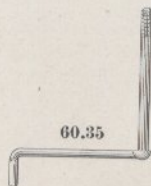
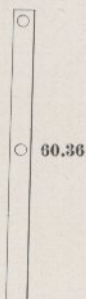
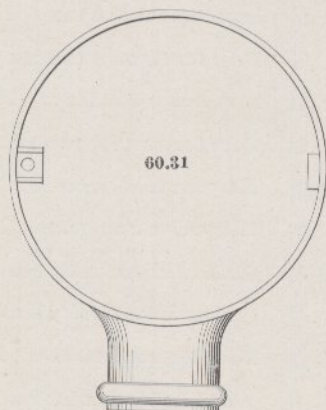

Order No.	IRON INDICATOR BOX AND POST.	Price.
<b>Section 60.</b>		
60.30	Iron Indicator Box and Post, complete .....	\$10.00
60.31	Box Casting.....	5.00
60.32	Ring for glass.....	.15
60.33	Glass.....	.20
60.34	Pipe 2½" x 8'.....	3.50
60.35	Locking Crank.. ..	.35
60.36	Locking Bar .....	.35
60.37	Cover.....	1.00

### Trunking, Channel Pins, etc.

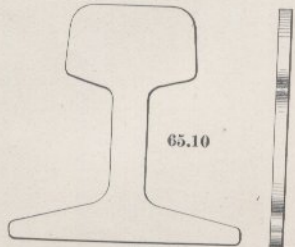
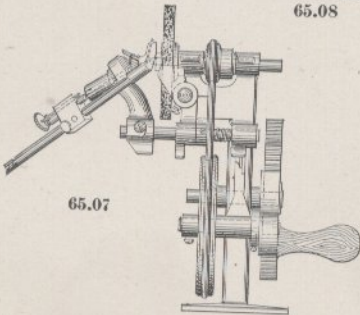
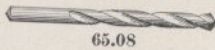
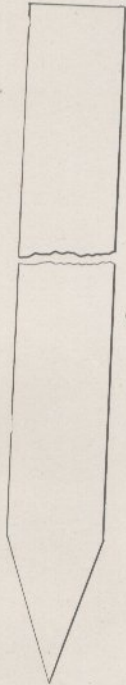
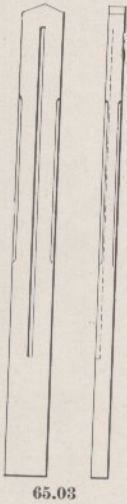
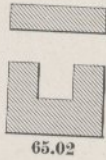
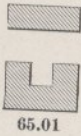



Order No.	TRUNKING, ETC.	Price.
<b>Section 65.</b>		
65.01	Small Trunking 2" x 3", cover 1" x 3", per foot .....	\$0.05
65.02	Large Trunking 3" x 4", cover 1" x 4", " " .....	.08
65.03	Relay and Indicator Box Posts .....	2.50
65.04	Channel Pin Drivers .....	.50
65.05	$\frac{9}{32}$ " Channel Pin, each .....	.02
65.06	Channel Pin Punches .....	.50
65.07	Drill Grinding Machine .....	35.00
65.08	$\frac{9}{32}$ " Twist Drills .....	.15
65.10	Fibre End Posts .....	.07
65.11	Trunking Stakes .....	.20
65.12	Hand Wheel for drill grinder .....	2.50
65.13	.....	
65.14	.....	
65.15	Graphite Resistance Blocks (state resistance) .....	.75
65.16	Graphite Rod only (state resistance) .....	.50
65.17	Clamps for holding graphite, each .....	.10
65.18	Wood Base .....	.10

### Drilling Machine, Style B.

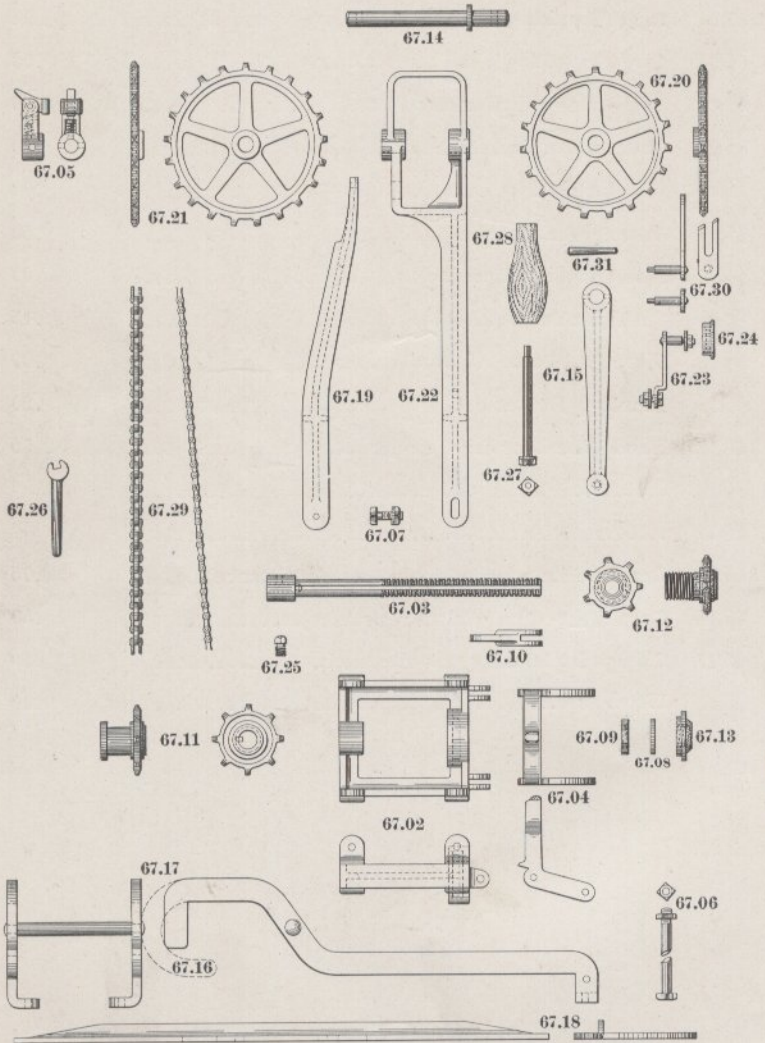

Order No.	<b>DRILLING MACHINE.</b>	Price.
	<b>Section 67.</b>	<b>Style B.</b>
67.01	Drilling Machine for web of rail.....	\$25.00
67.02	Sliding Frame .....	2.50
67.03	Spindle.....	2.00
67.04	Toggle Lever .....	.50
67.05	Pawl and Arm .....	1.50
67.06	Toggle Lever Bolt.....	.10
67.07	Machine Bolt .....	.10
67.08	Washer for adjusting nut .....	.40
67.09	Adjusting Nut for ball bearing .....	.70
67.10	Toggle .....	.40
67.11	Drive Sleeve, eight teeth .....	3.00
67.12	Feed Nut, sprocket seven teeth .....	3.00
67.13	Cone for ball bearing .....	1.50
67.14	Crank Shaft.....	1.50
67.15	Crank .....	1.50
67.16	Rail Hook .....	1.50
67.17	Rail Hook .....	1.50
67.18	Foot Plate .....	1.00
67.19	Upright Frame Brace.....	1.00
67.20	Feed Sprocket, 19 teeth .....	2.00
67.21	Drive Sprocket, 21 teeth.....	2.00
67.22	Upright Frame.....	5.00
67.23	Idler Bracket.....	.30
67.24	Idler Wheel.....	.40
67.25	Set Screw.....	.10
67.26	Small Wrench .....	.25
67.27	Shaft for wood handle .....	.10
67.28	Wood Handle .....	.15
67.29	Feed Chain, 47 links.....	1.30
67.30	Idler Adjusting Plate.....	.30
67.31	Taper Pin.....	.05
67.32	$\frac{1}{4}$ " Balls, each.....	.01
67.33	Feed Chain, 48 links.....	1.30

## Drilling Machine, Style A.

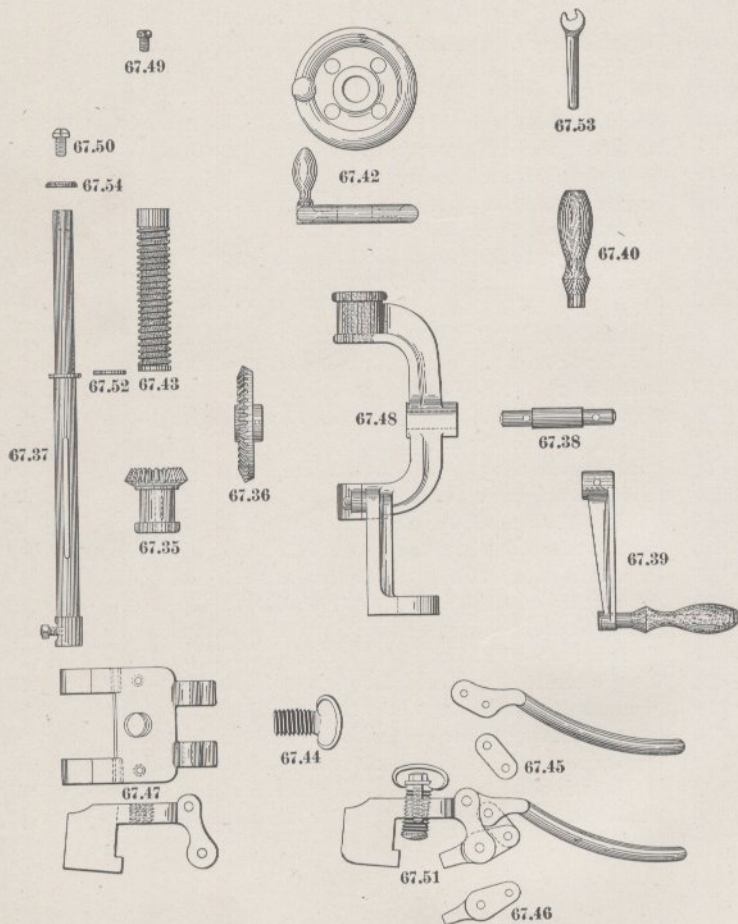

Order No.	<b>DRILLING MACHINES.</b>		Price.
	<b>Section 67.</b>	<b>Style A.</b>	
67.34	Drilling Machine for base of rail (give size of rail)...		\$25.00
67.35	Spindle Gear.....		2.00
67.36	Main Gear.....		2.50
67.37	Spindle.....		2.00
67.38	Main Gear Shaft.....		.50
67.39	Crank, complete.....		1.60
67.40	Handle only.....		.15
67.41	Clamp Lever.....		.75
67.42	Feed Handle.....		1.00
67.43	Feed Screw.....		2.50
67.44	Set Screw for clamp.....		.15
67.45	Clamp Link.....		.25
67.46	Clamp Dog.....		.20
67.47	Foot Piece (give size of rail).....		5.00
67.48	Frame.....		5.00
67.49	Set Screw for holding drill.....		.10
67.50	Left hand Screw for top of spindle.....		.10
67.51	Assembled Foot Piece, complete.....		7.00
67.52	Washer for main gear shaft.....		.03
67.53	Small Wrench.....		.25
67.54	Washer for top of spindle.....		.03

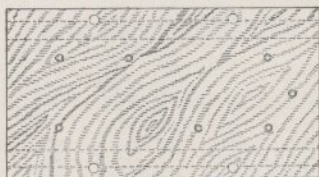

70.03

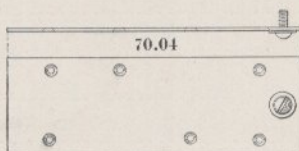

70.04



70.07

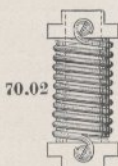

70.02



70.05

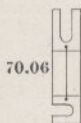

70.06



70.10



70.08



70.09

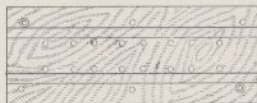

70.18

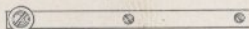

70.19

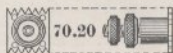

70.20

Order No.	<b>LIGHTNING ARRESTERS.</b>	Price.
<b>Section 70.</b>		
70.01	Style E Arrester (per point).....	\$0.75
70.02	Porcelain Block, wound, with iron core.....	.40
70.03	Base (give No. of points) four point .....	.15
70.04	Ground Plate (give No. of points) four point.....	.10
70.05	Slate Bridge Piece, with small binding post and nuts	.30
70.06	Mica Fuse .....	.03
70.07	Binding Posts .....	.10
70.08	Binding Post Nuts, each.....	.05
70.09	Binding Post for bridge piece.....	.03
70.10	$\frac{1}{8}$ " Washers.....	.001 $\frac{1}{2}$
70.15	Style G Arrester (per point).....	.50
70.18	Base (four point).....	.15
70.19	Ground Plate, with screws.....	.10
70.20	Binding Post, complete, with toothed base and screws.....	.20
<b>Extra for Style E-G Arrester.</b>		
70.25	Style E-G Arrester (per point).....	1.25
70.26	Slate Bridge Piece, complete, with middle binding post and toothed plate.....	.25
70.27	Ground Plate, with screws.....	.10

### Lightning Arrester, Style E. G.

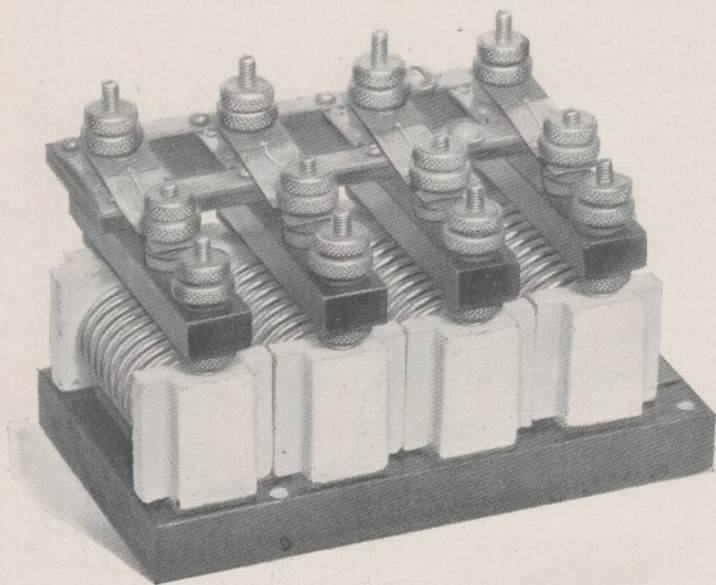

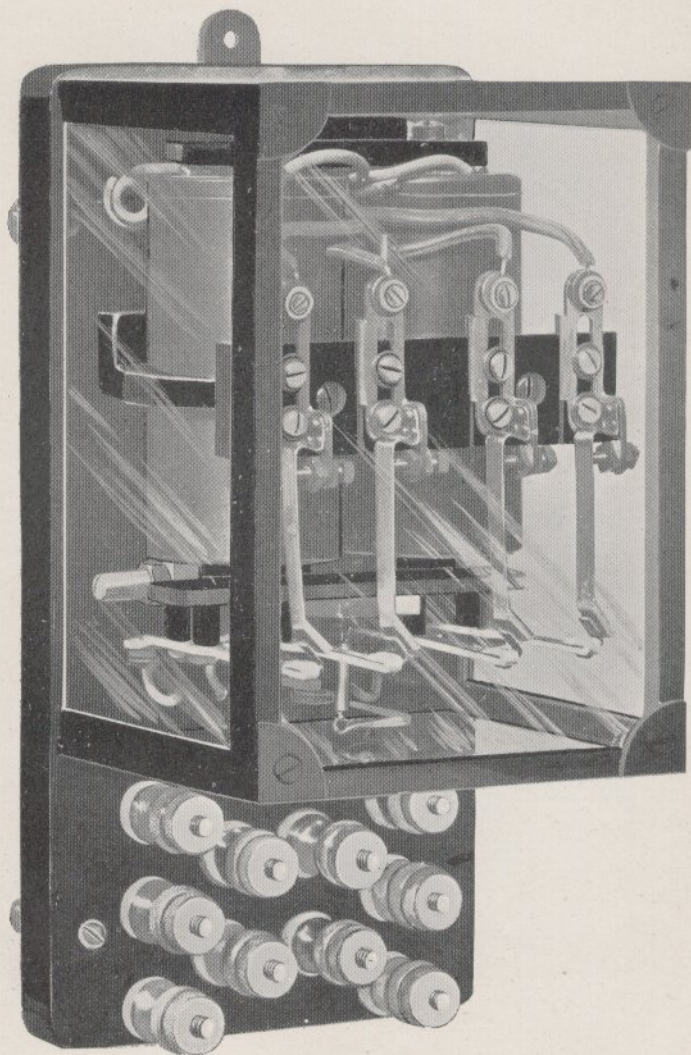

**Standard Relay, glass enclosed.**

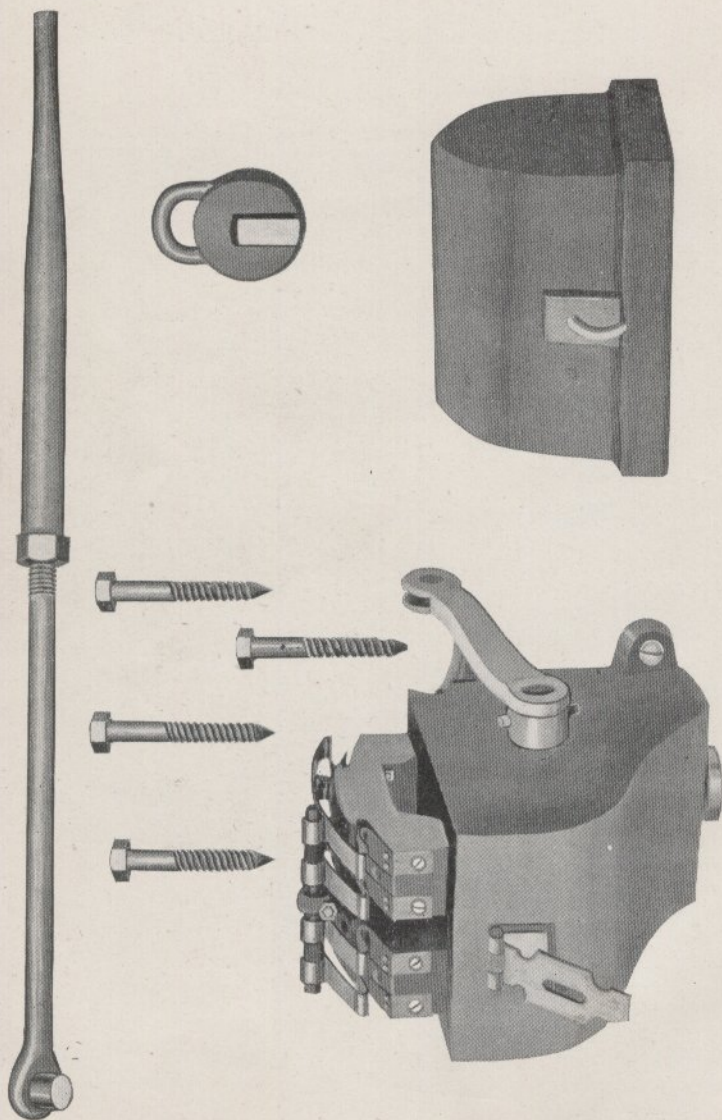

Commutator Instrument, Style A.

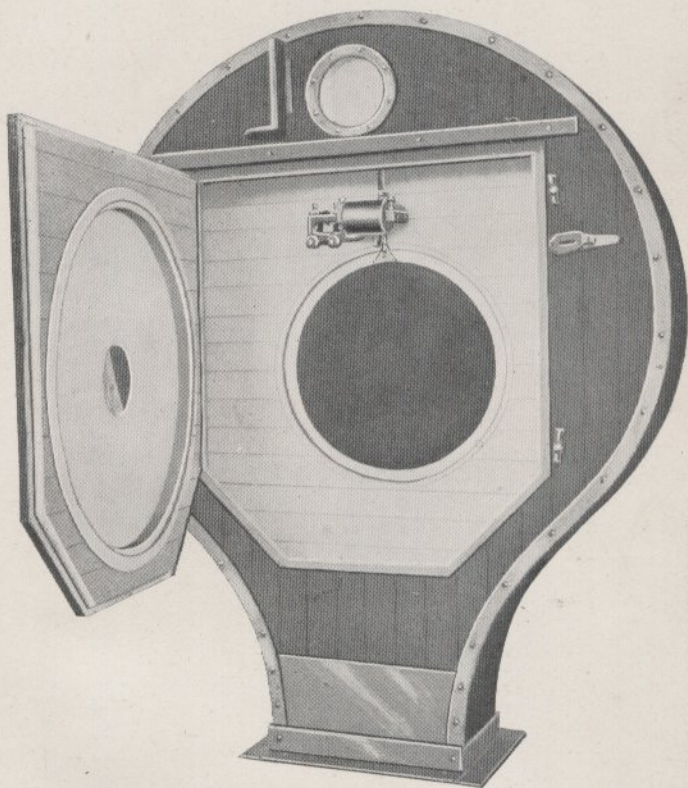
**Signal Case, Style B Instrument.**

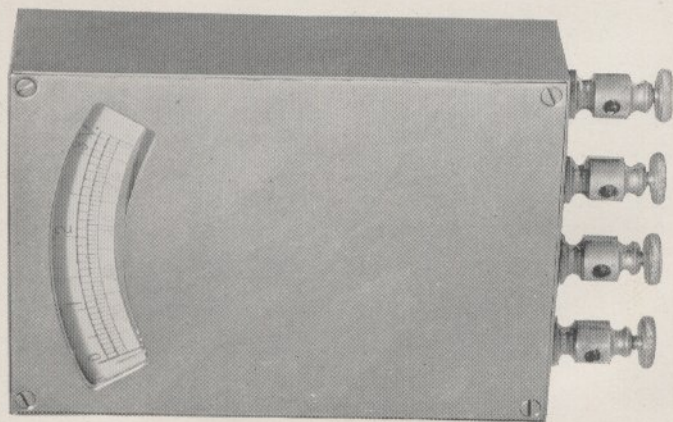
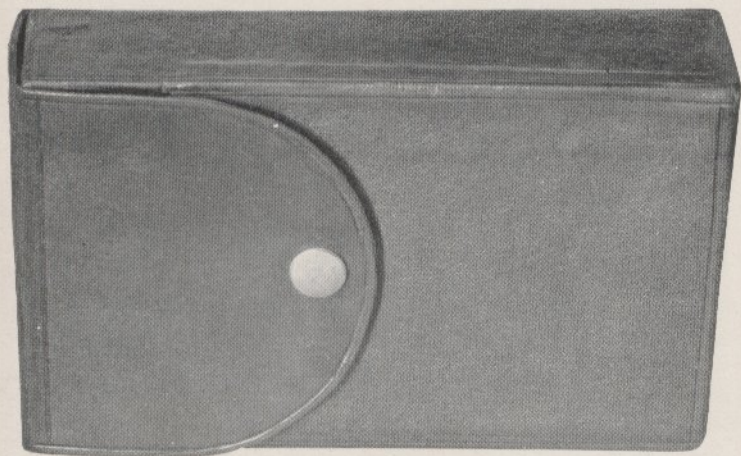

Volt Am-Metre.



Standard Disc Signal.

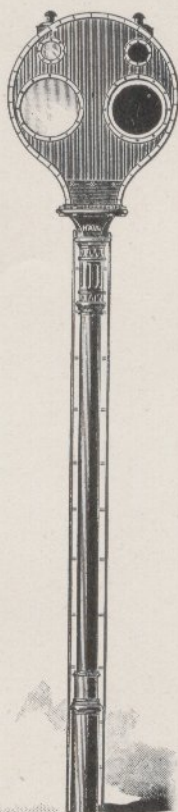

Route Signal.

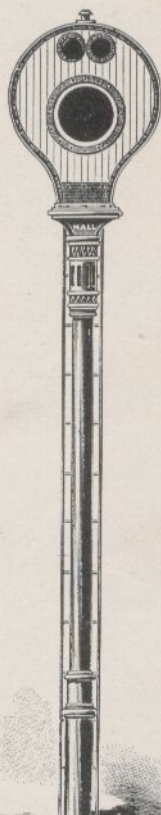

C. & N. W. Standard  
Distant Signal.

