

CONNECTS TO SHEET 71

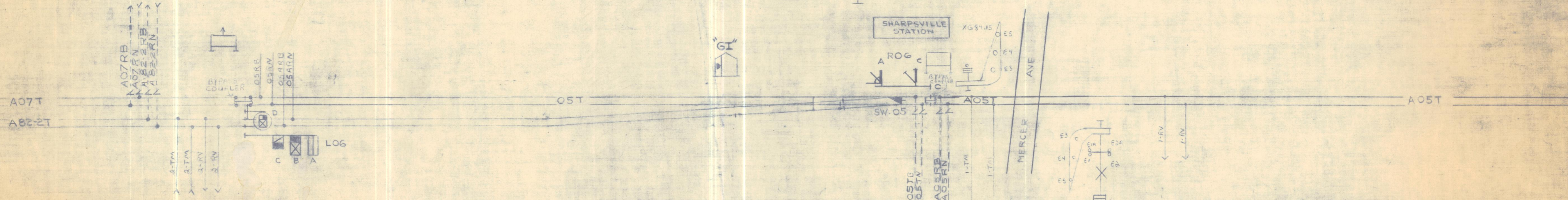
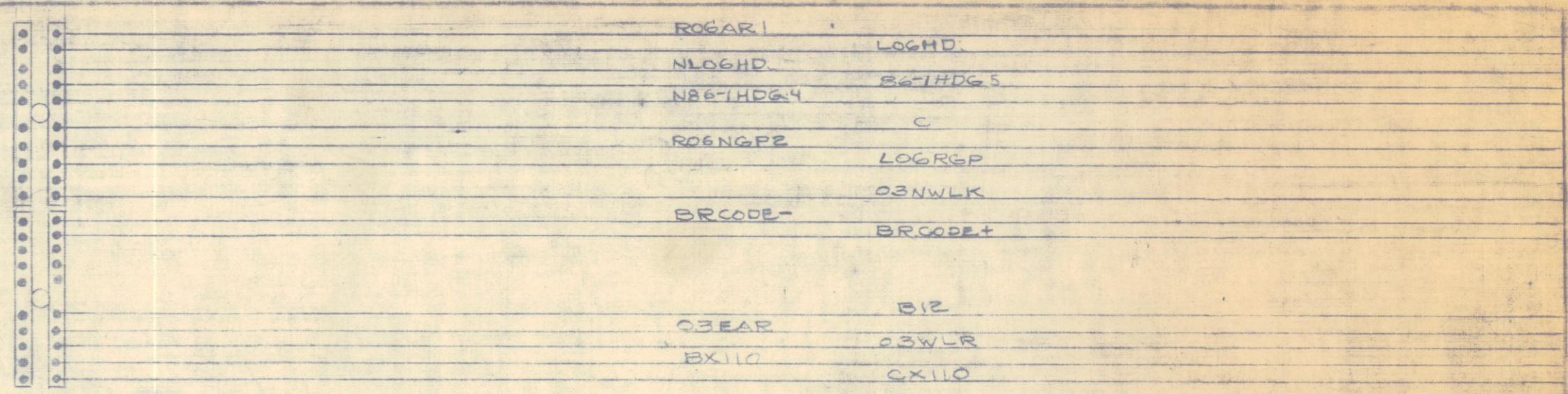
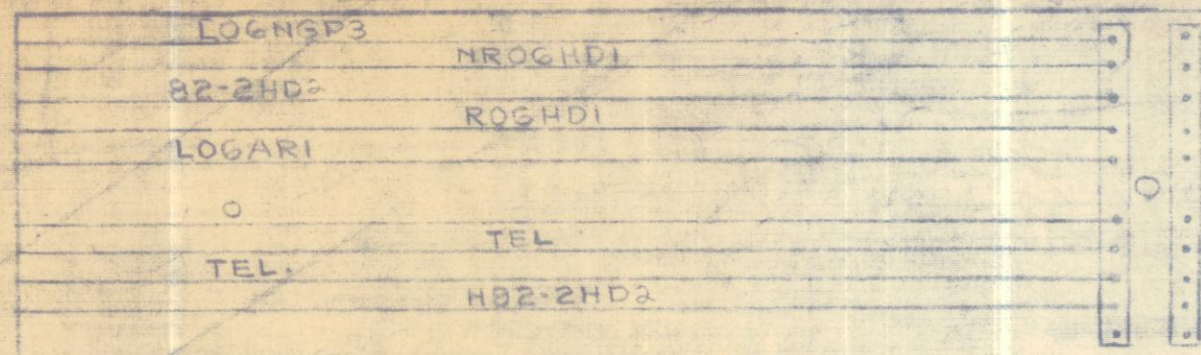

DATE	REVISIONS
11-15-63	SHEWAGO RIVER FLOOD CONTROL
5-28-66	ROW SIG TO COLOR LIGHT
3-21-72	REVISIONS IN SERVICE [unclear]
4-30-47	GI REMOTE CONTROLLED FROM GI
7-7-52	REMOTE CONTROL OF "GH" FROM "SN"
12-29-61	SW HEATERS INST. ON O3 & O5 SWS.

GI SHARPSVILLE PA SHEET #1 OF 15 SHEETS

6502-0841
1ST DIST. MAHONING DIVISION SHEET 72

CONNECTS TO SHEET 1 OF SHEET #72 1/2

ROUTE CHECK NETWORK

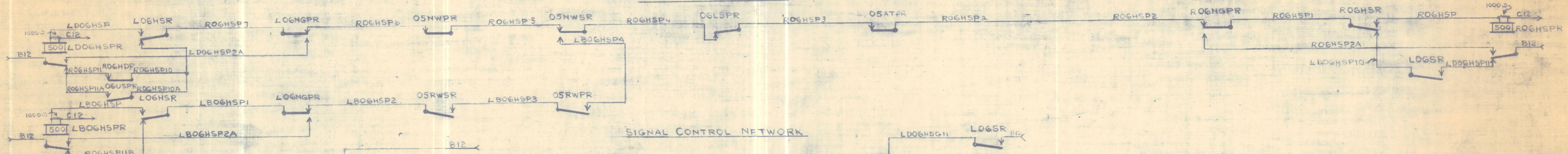

SIGNAL CONTROL NETWORK

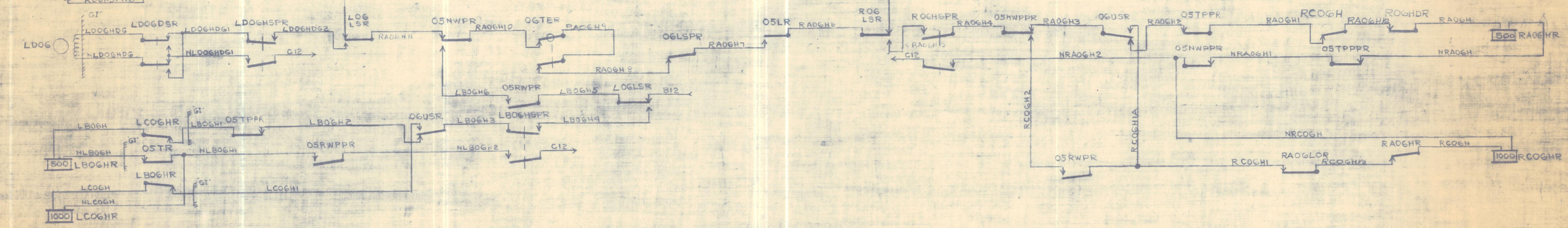

3-31-78
 REVISED AS
 SERVICE
 PER R.H.D.
 3-3-78 JSC JFC

GI SHARPSVILLE, PA.
 SHEET #2 OF 15 SHEETS

REV. 5-28-68

MAHONING DIVISION SHEET 72

GI 03 CASE

LOCK CIRCUITS

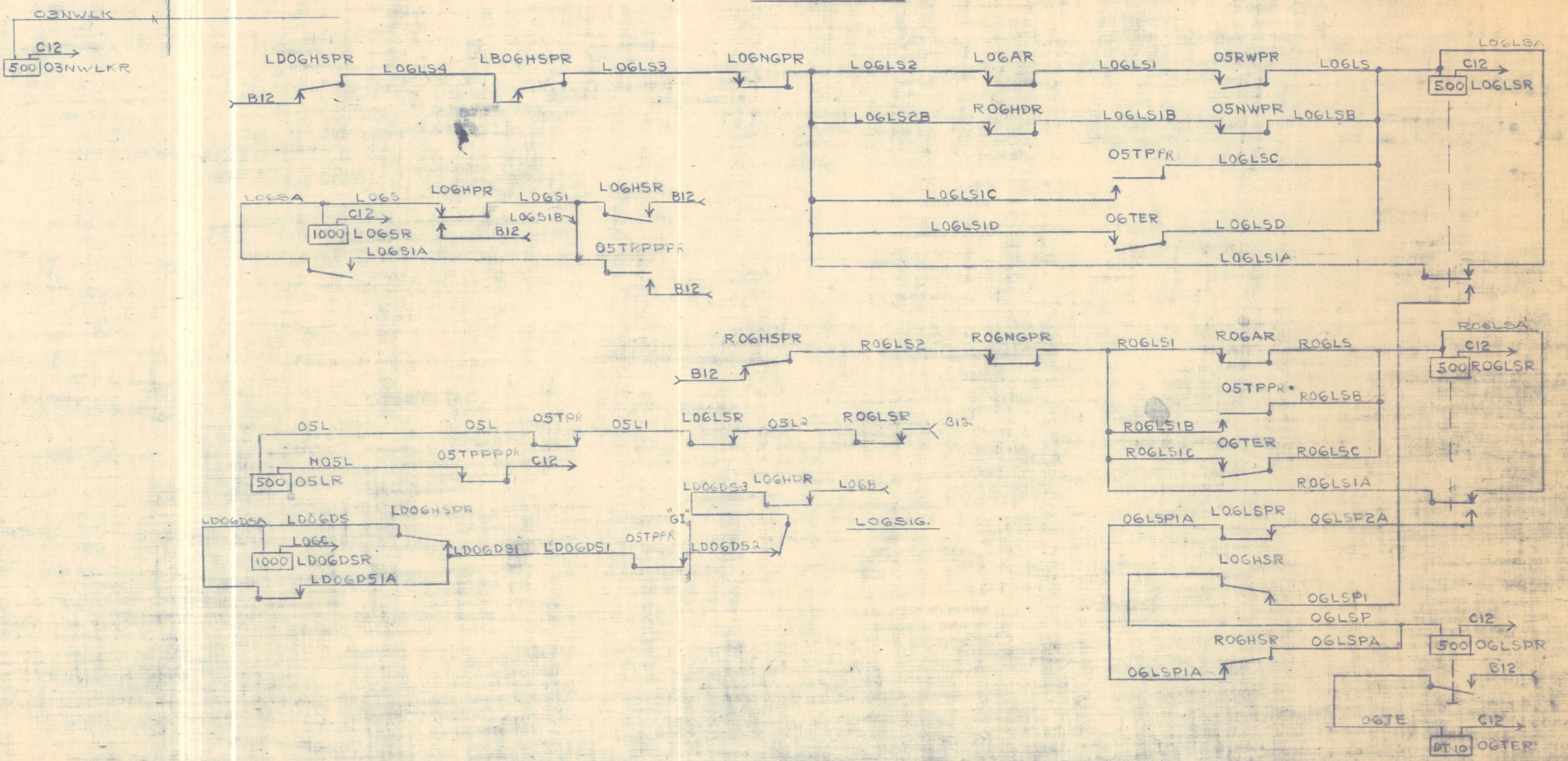

2-21-78
 REV. AS
 IN SERVICE
 2-3-78 PER
 RHD ASC JFS

GI SHARPSVILLE, PA.
 SHEET #4 OF 15 SHEETS

REV. 5-28-68

DIST. MAHONING DIVISION SHEET 72

LCS - STATION #245

INDICATIONS #245

EMERGENCY MANUAL CONTROL UNIT FOR STATION #345-346

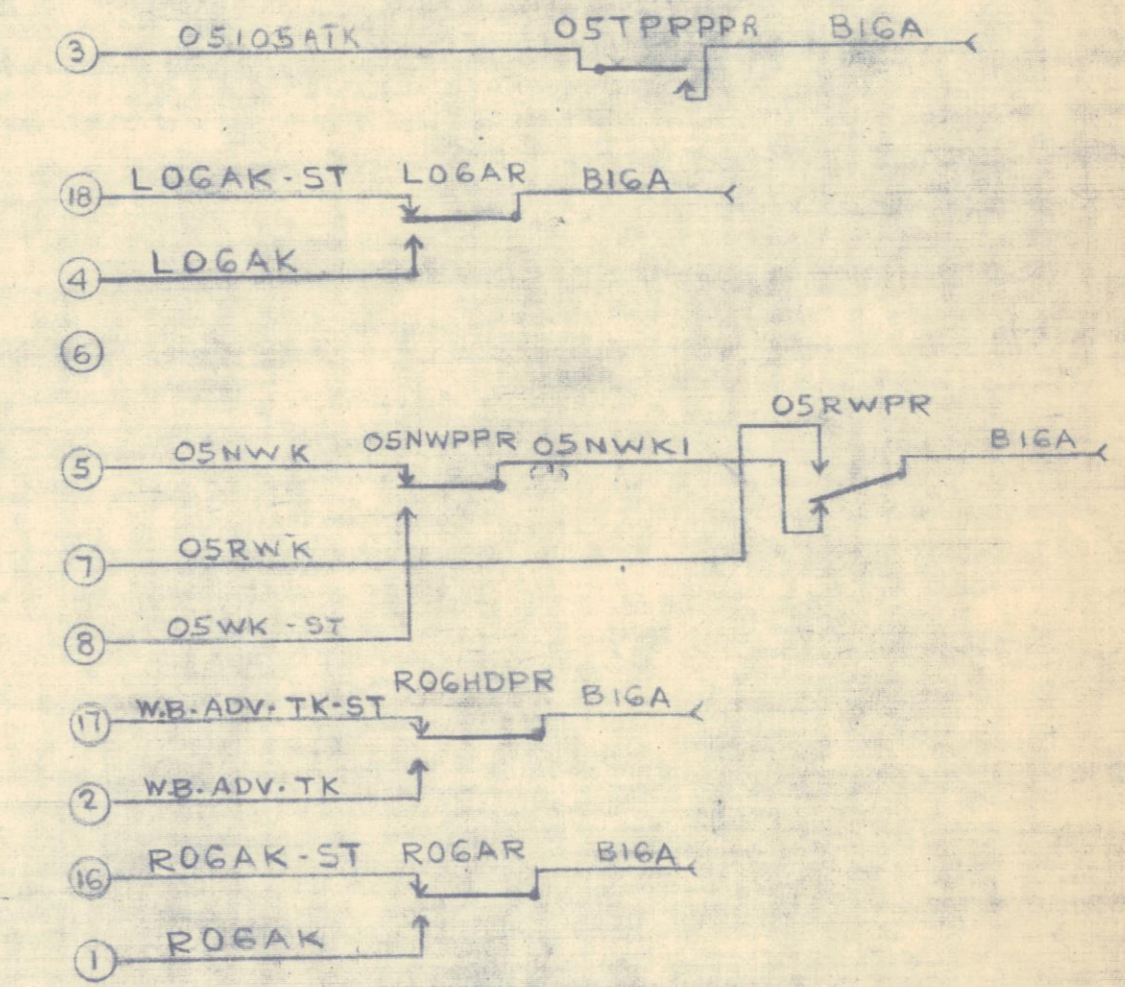
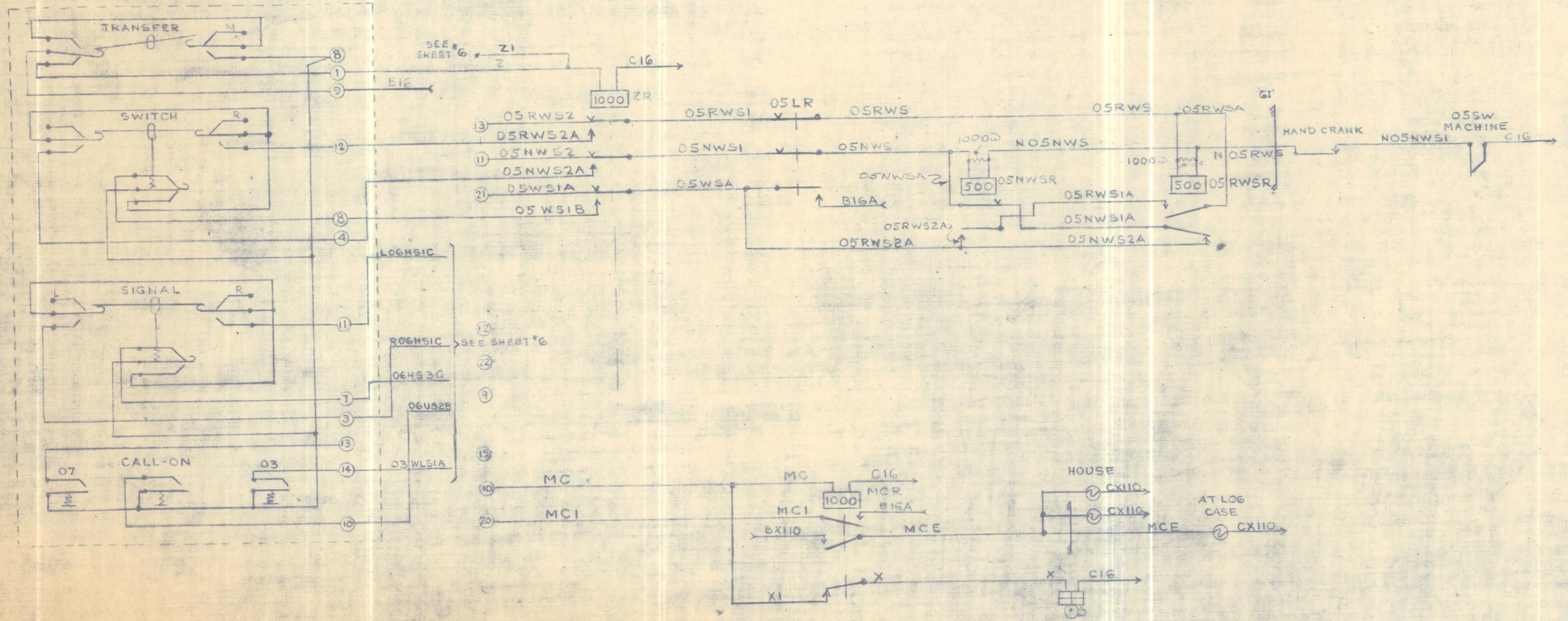

GI SHARPSVILLE LCS & Storage Unit Jumpers For Station Selection		JUMPERS BETWEEN TERMINAL POSTS OF LCS UNIT							
STATION	UNIT	59-52	60-54	55-26	51-25	69-62	70-64	65-29	
245	LCS								
		JUMPERS BETWEEN TERMINAL POSTS ON LCS AND STORAGE UNIT							
246	STORAGE	66-29	56-26						

MULTIPLE CONNECTIONS BETWEEN LIKE NUMBERED TERMINAL POSTS ON LCS AND STORAGE UNITS: 24-25-27-28-30-31-32-33-34-35-36-37-38-39-40-41-42-43-44-45-46-47-48-49-50

3-31-78
REV. AS
IN SERVICE
3-3-78 PER RMD
ASC JFS

GI SHARPSVILLE, PA.
SHEET #5 OF 15 SHEETS

CONTROL - STORAGE UNIT #246

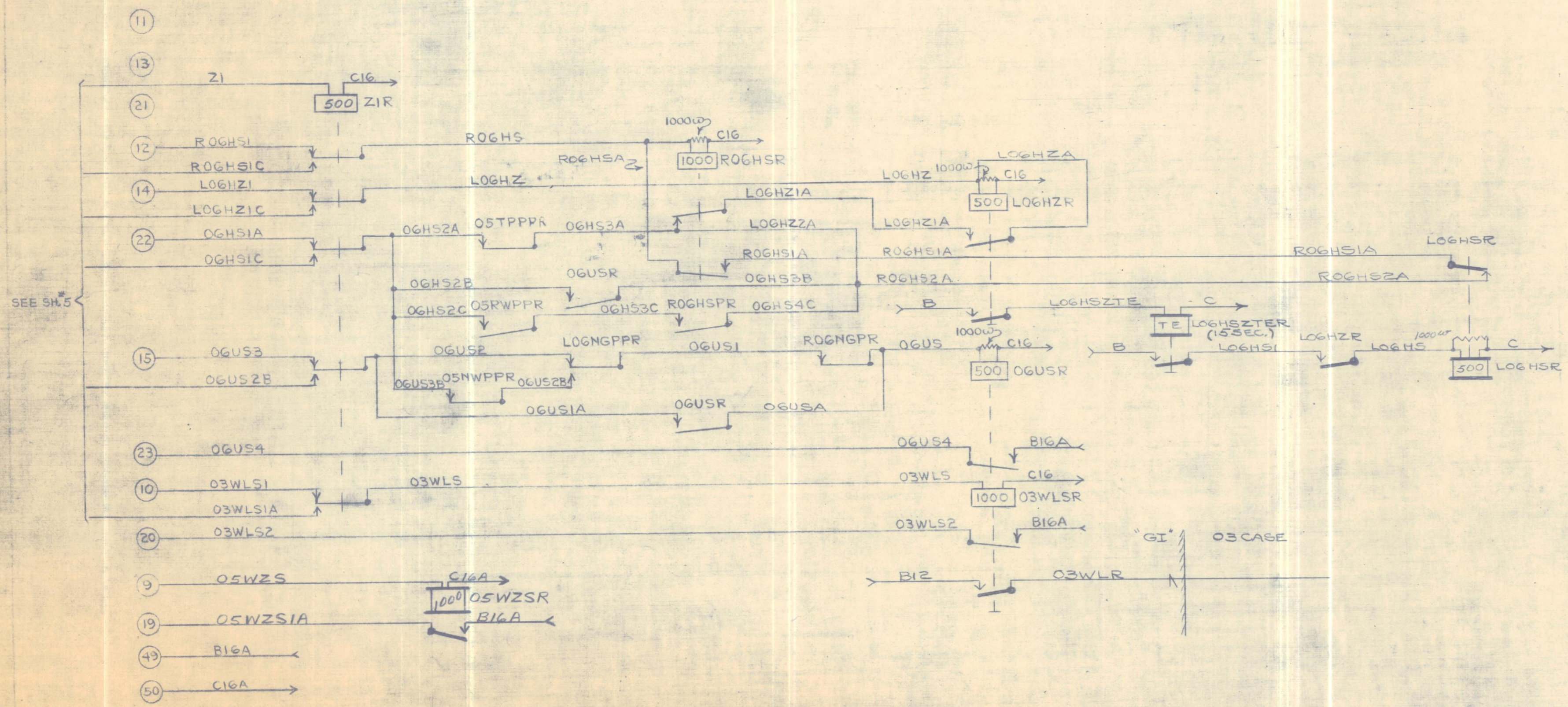

INDICATION - STORAGE UNIT #246

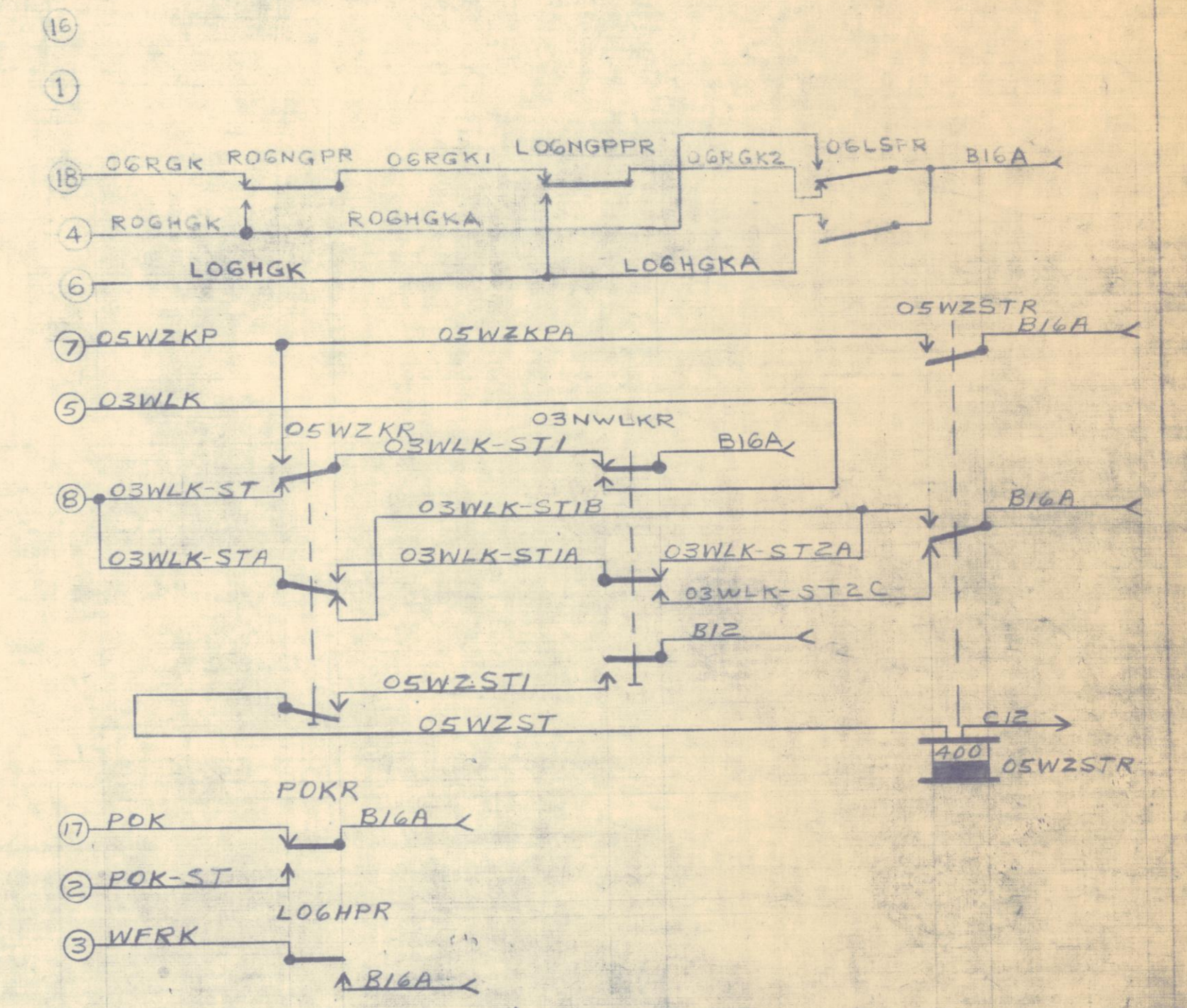

REV. 5-28-68

3-21-78
REV AS
IN SERVICE
3-3-78
PER RHD ASC JFS

GI SHARPSVILLE, PA.
SHEET #6 OF 15 SHEETS

1ST DIST. MAHONING DIVISION SHEET 72
6502-0841

PEN RECORDER

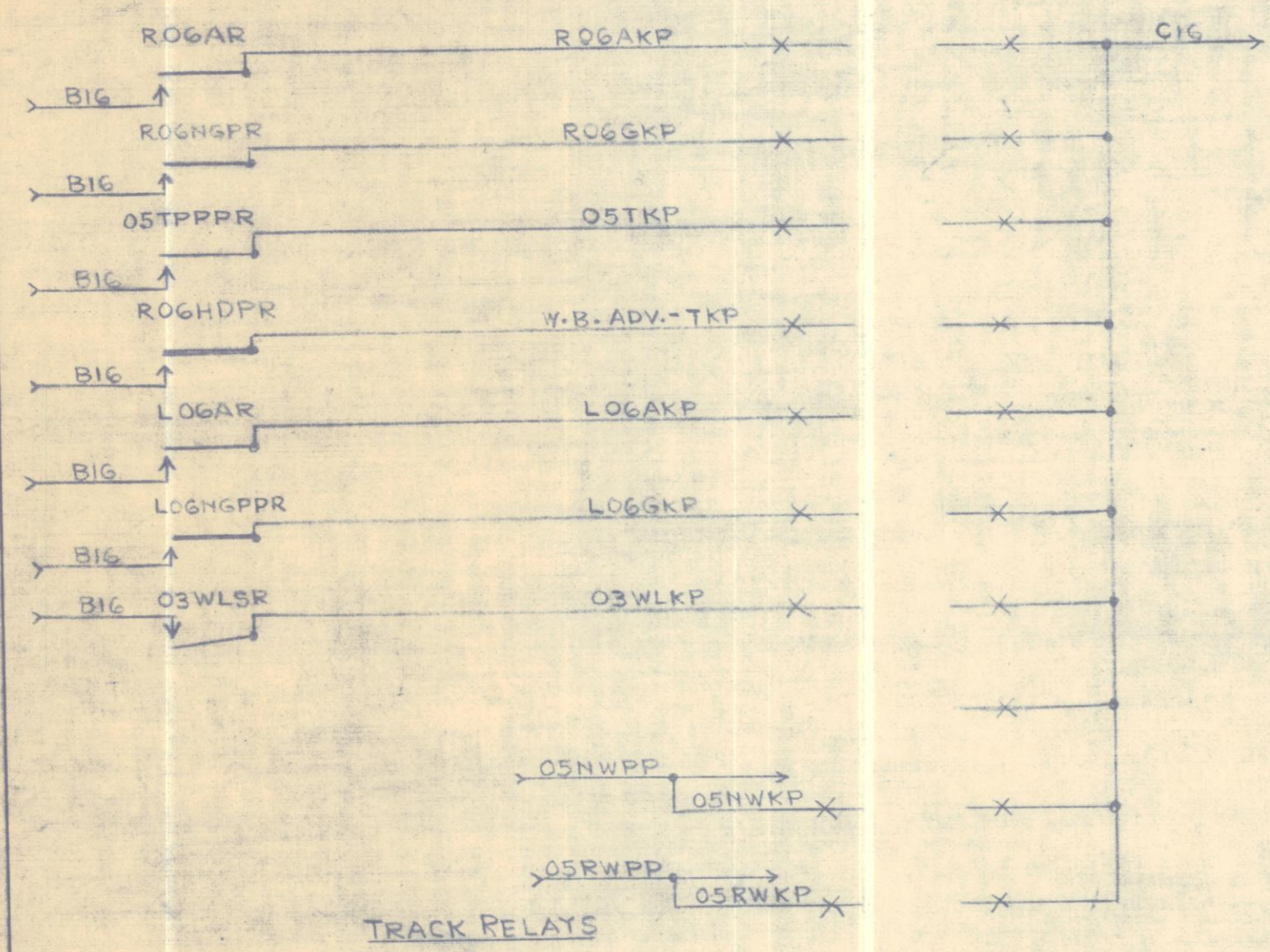

TRACK RELAYS

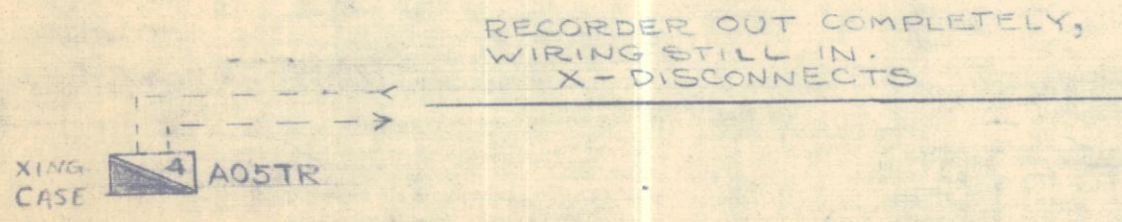

REPEATER CIRCUITS

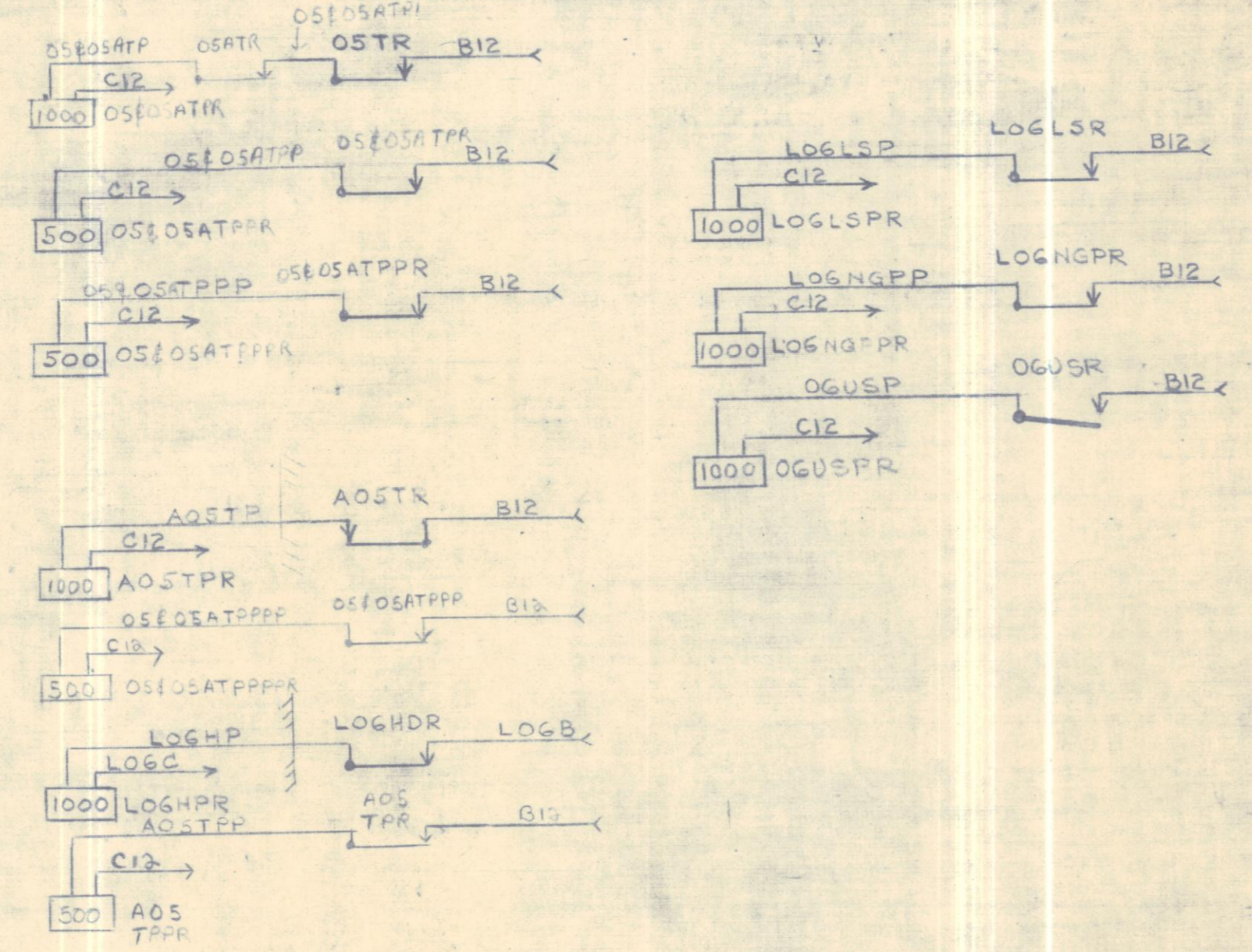

REV. 5-28-68

1ST DIST. MAHONING DIVISION SHEET 72

3-31-78
REV. AS
IN SERVICE
3-3-78 PER RHD
MSC/JFS

GI SHARPSVILLE, PA.
SHEET 7 OF 15 SHEETS

6502-084

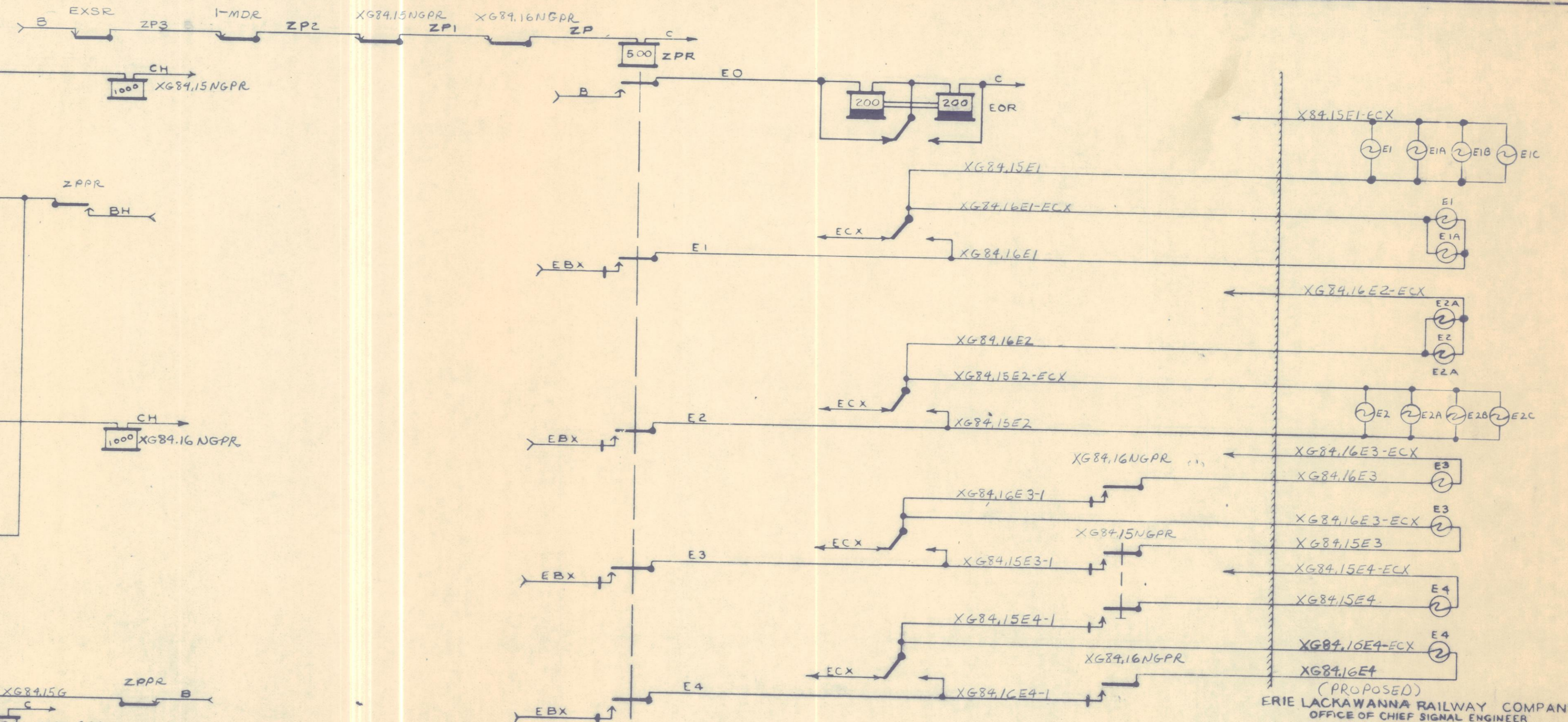
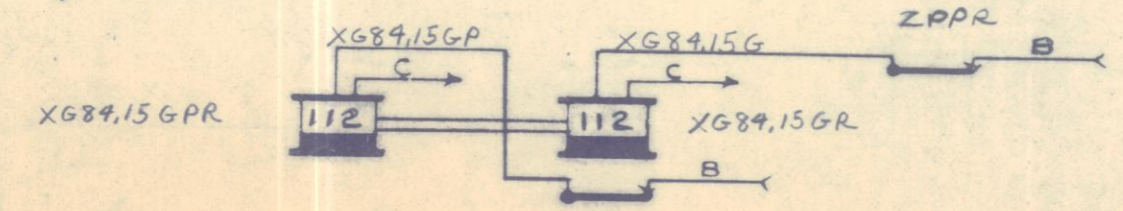
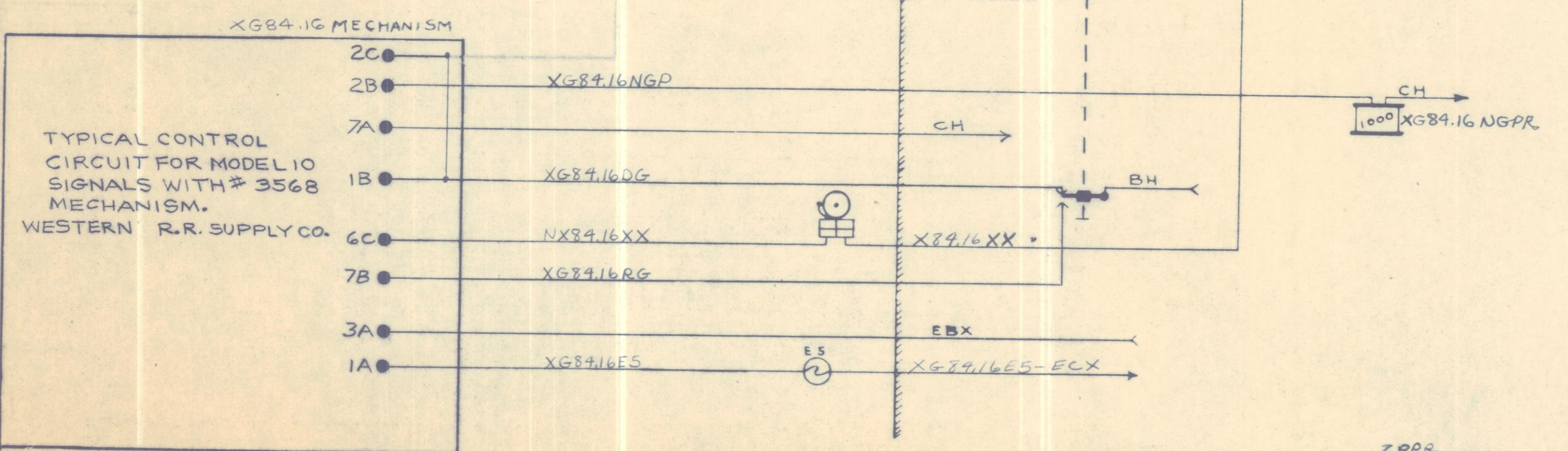
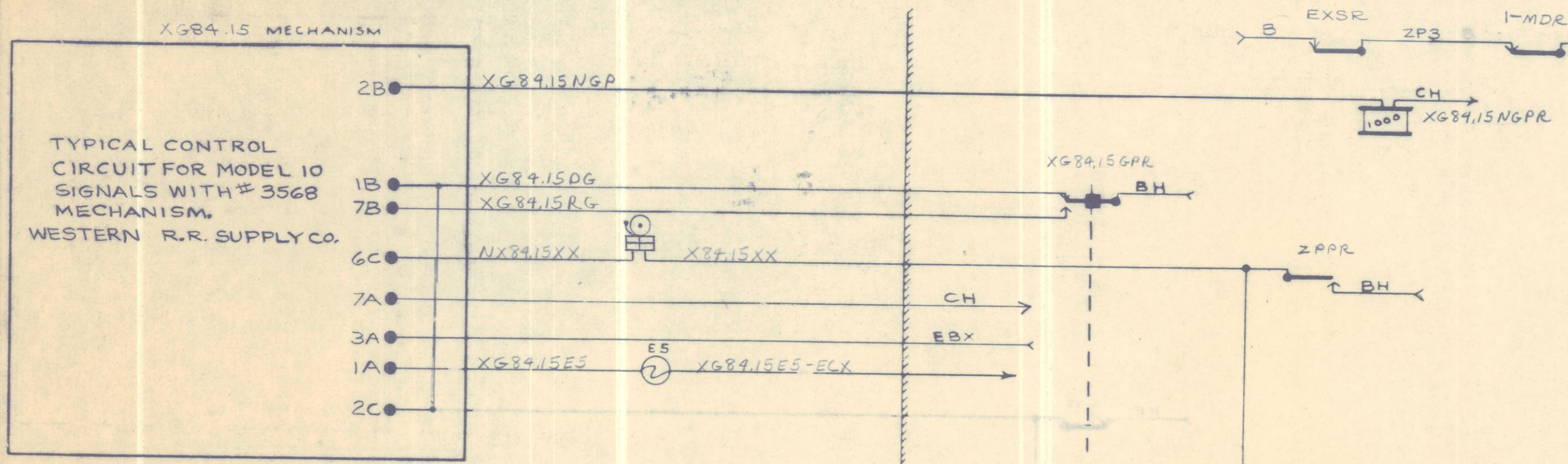

(PROPOSED)
 ERIE LACKAWANNA RAILWAY COMPANY
 OFFICE OF CHIEF SIGNAL ENGINEER
 CIRCUITS AT

3-21-78
 REV. AS
 IN SERVICE
 3-3-78 PER RHD
 ASC JFS

"GI" SHARPSVILLE, PA.

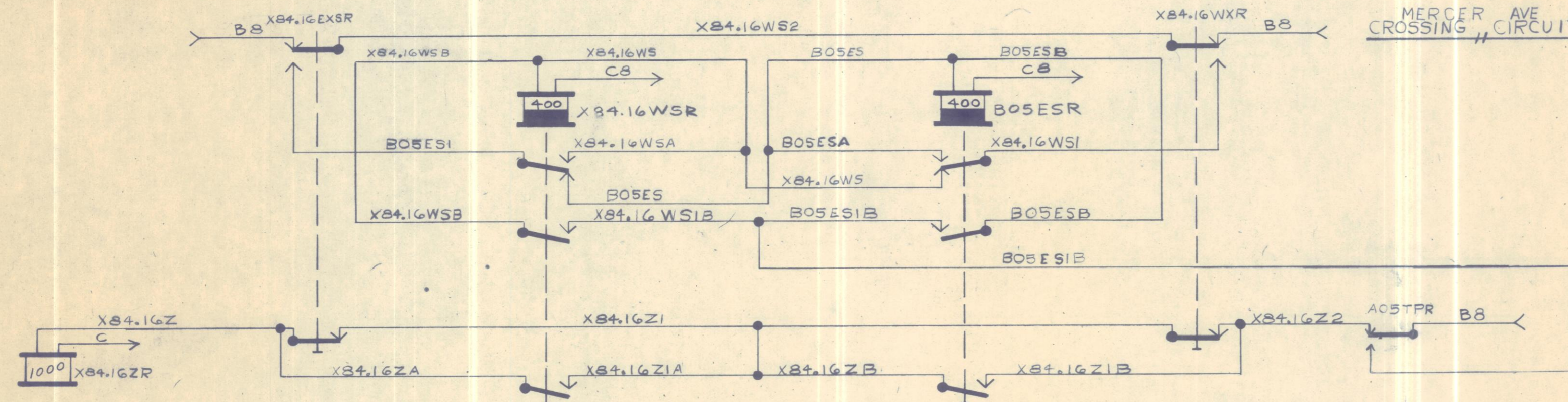

MERCER AVE CROSSING CIRCUITS

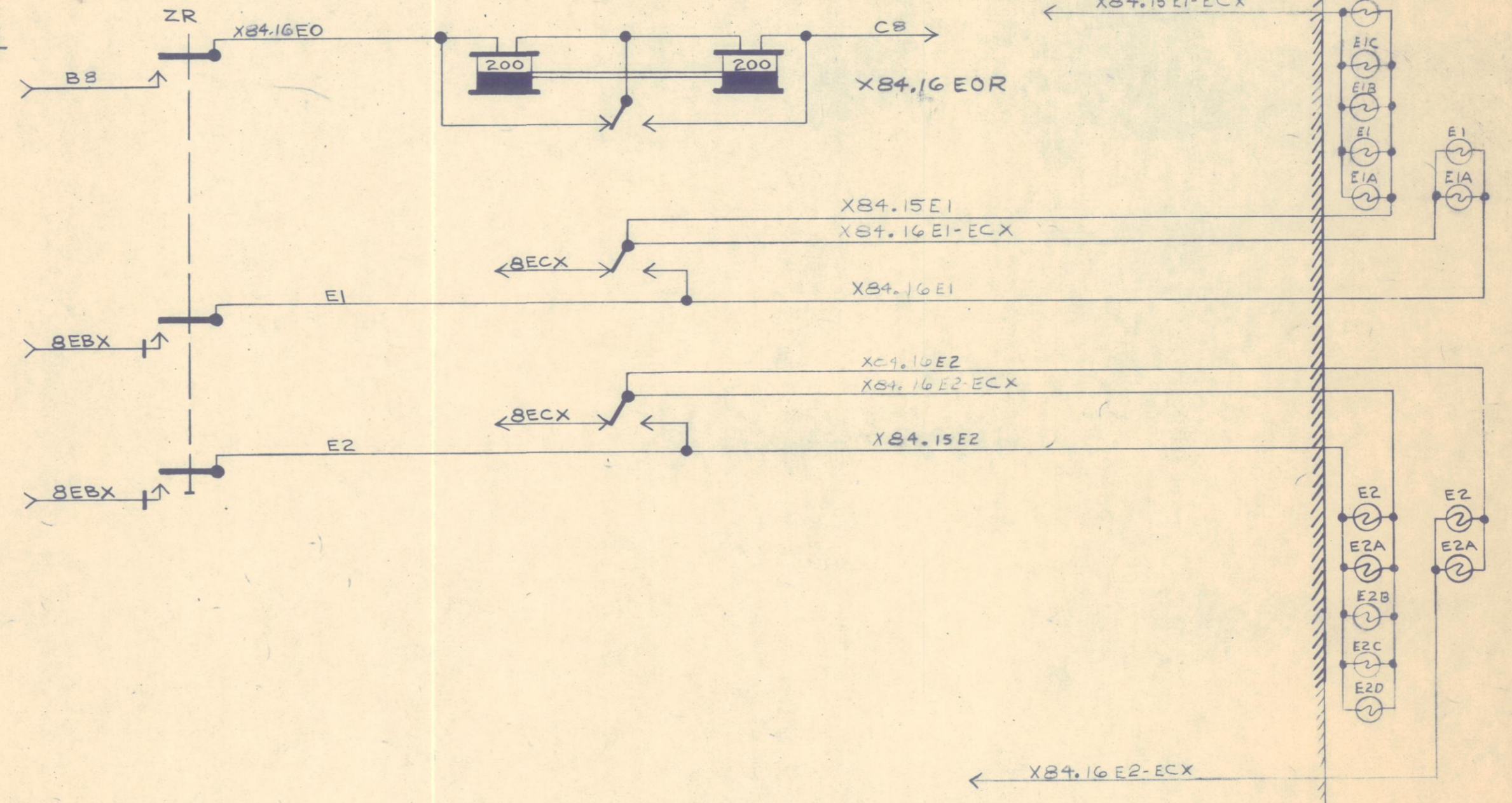

VOID

ERIE-LACKAWANNA RAILROAD COMPANY
 OFFICE OF CHIEF SIGNAL ENGINEER
 CIRCUITS AT
 "G1" SHARPSVILLE, PA.

CONTROL CIRCUIT FOR SINGLE SWITCH #05

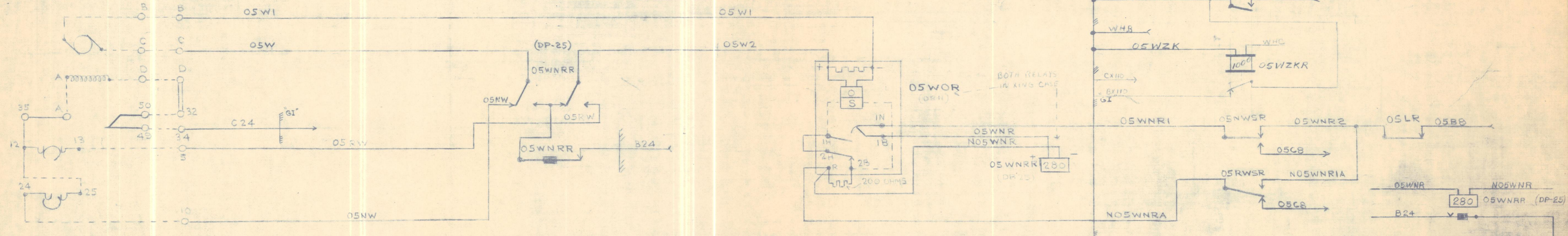

NEUTRAL SWITCH REPEATER CIRCUIT FOR SWITCH #05

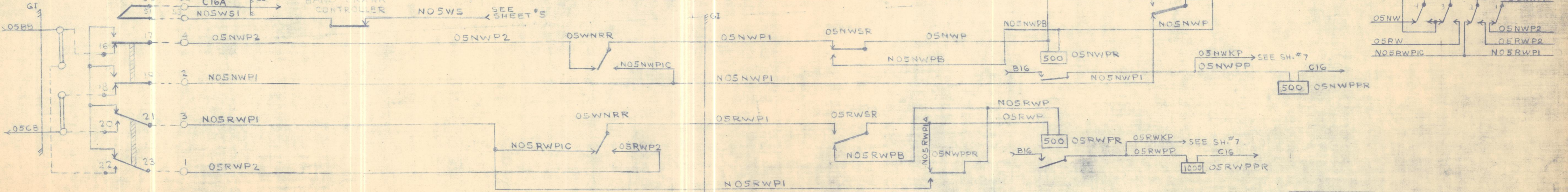

3-21-78
REV AS
IN SERVICE
3-3-78 PER RHD
JRC

"G1" SHARPSVILLE PA.
SHEET #9 OF 13 SHEETS

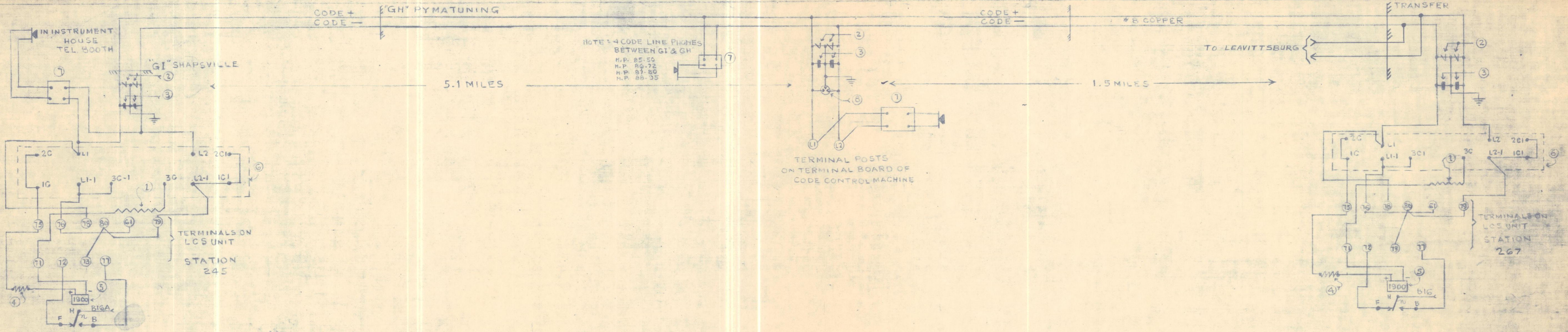

3-21-78
 REV. AS
 IN SERVICE
 3-8-78 PER RND
 ASC/JFS

"GI" SHARPSVILLE, PA.
 SHEET 10 OF 15 SHEETS

REV. 5-28-68

1ST DIST. MAHONING DIVISION SHEET 72
 6502-0541

LOG SIGNAL

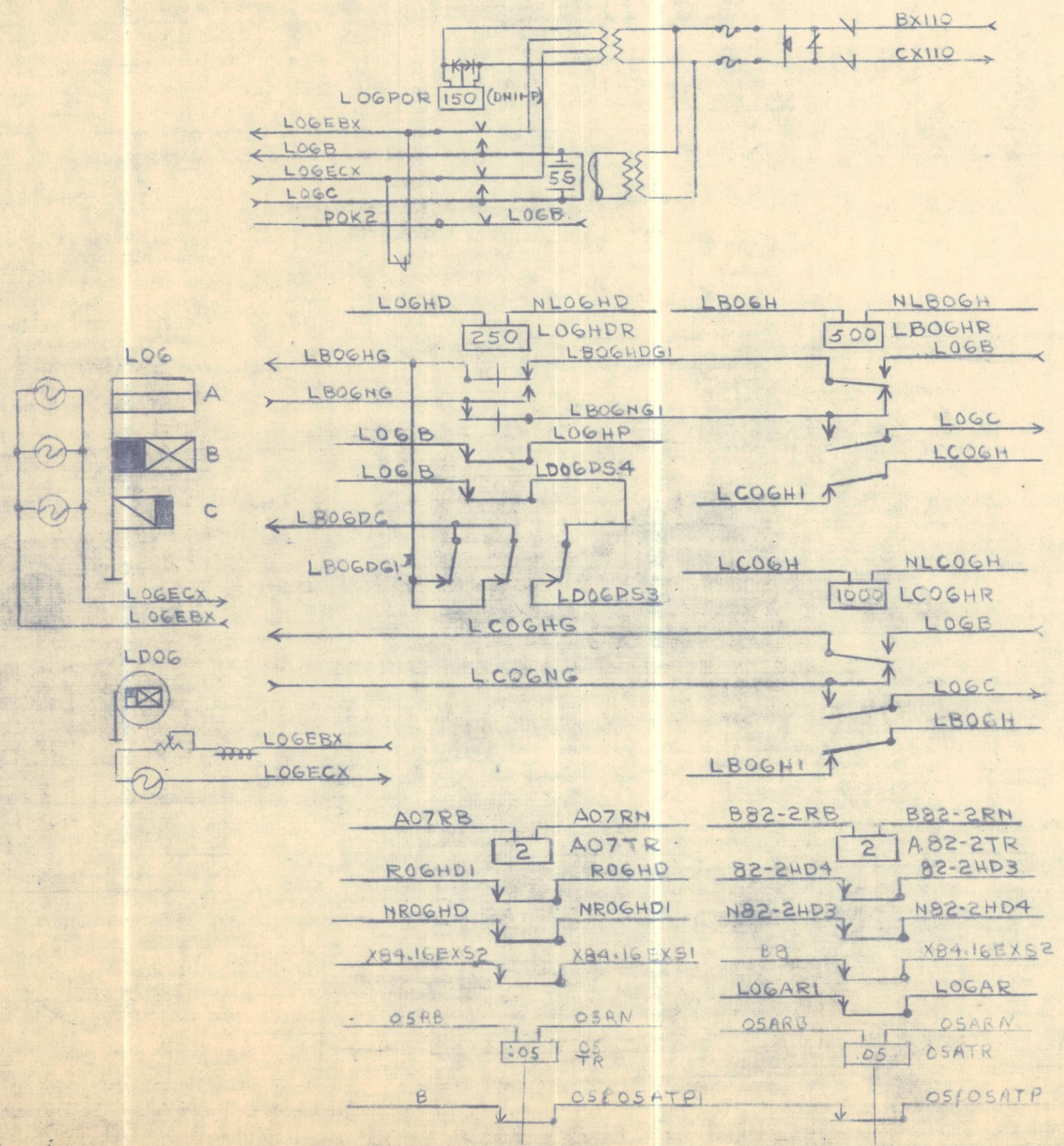

HOUSE

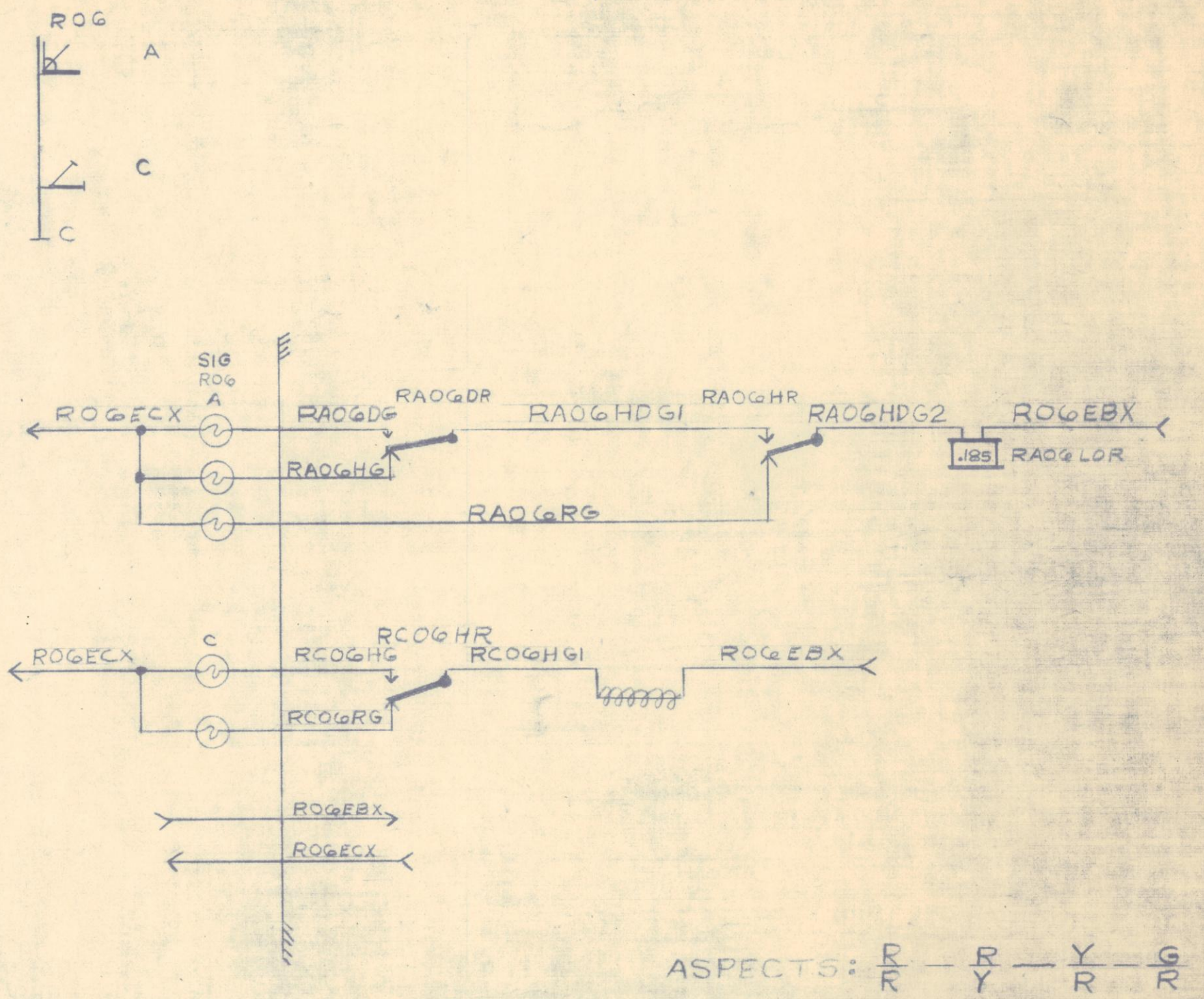
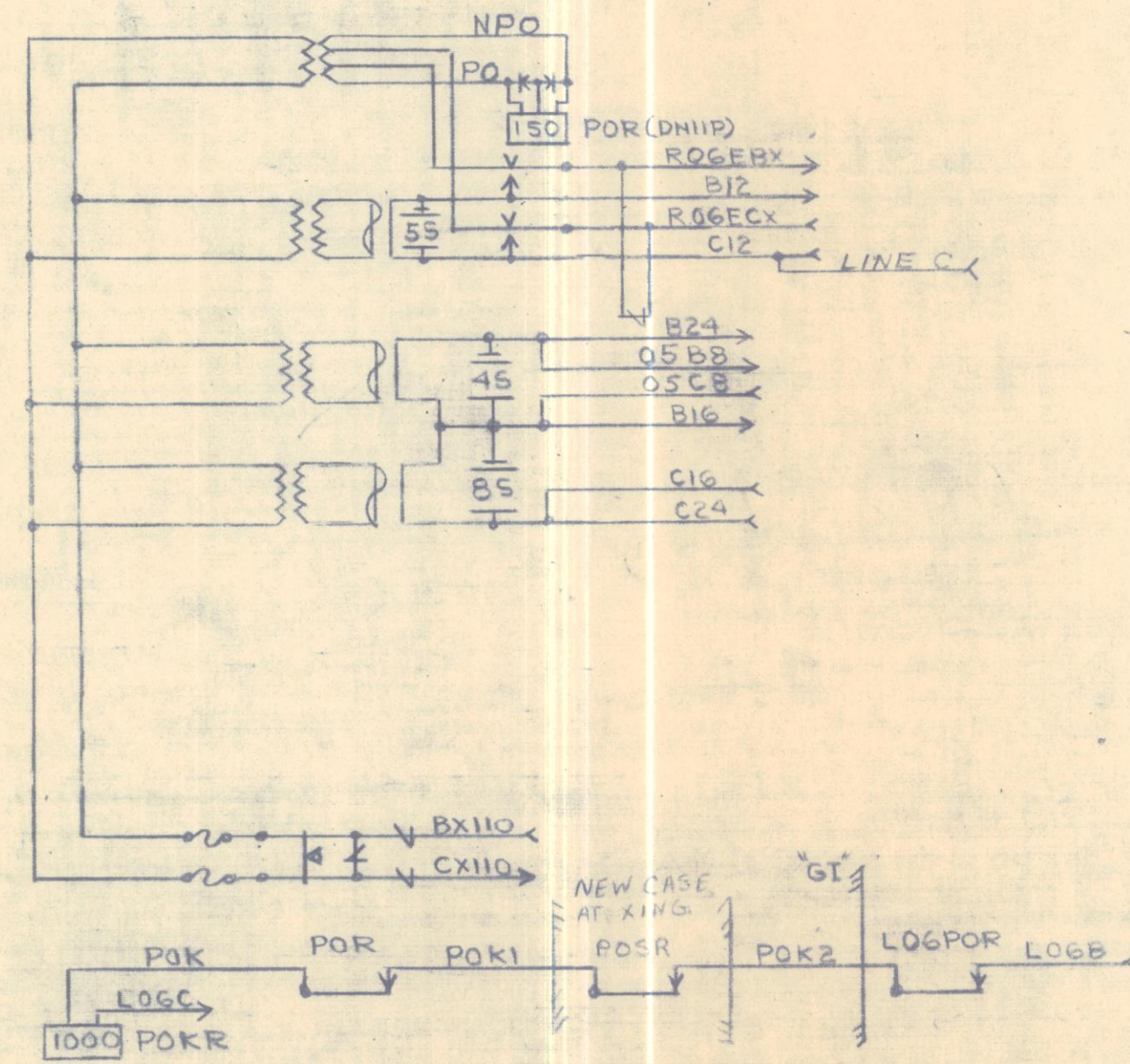

3-31-78
REV. AS
IN SERVICE
3-3-78 PER RHD
ASC JES

GI SHARPSVILLE, PA
SHEET #11 OF 15 SHEETS

6502-0841

REV. 5-29-68

1ST DIST. MAHONING DIVISION SHEET 72

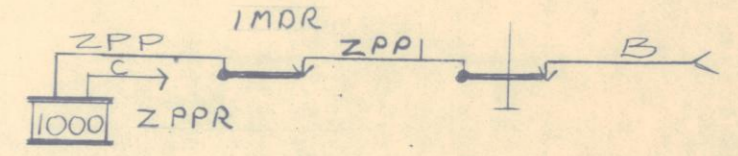
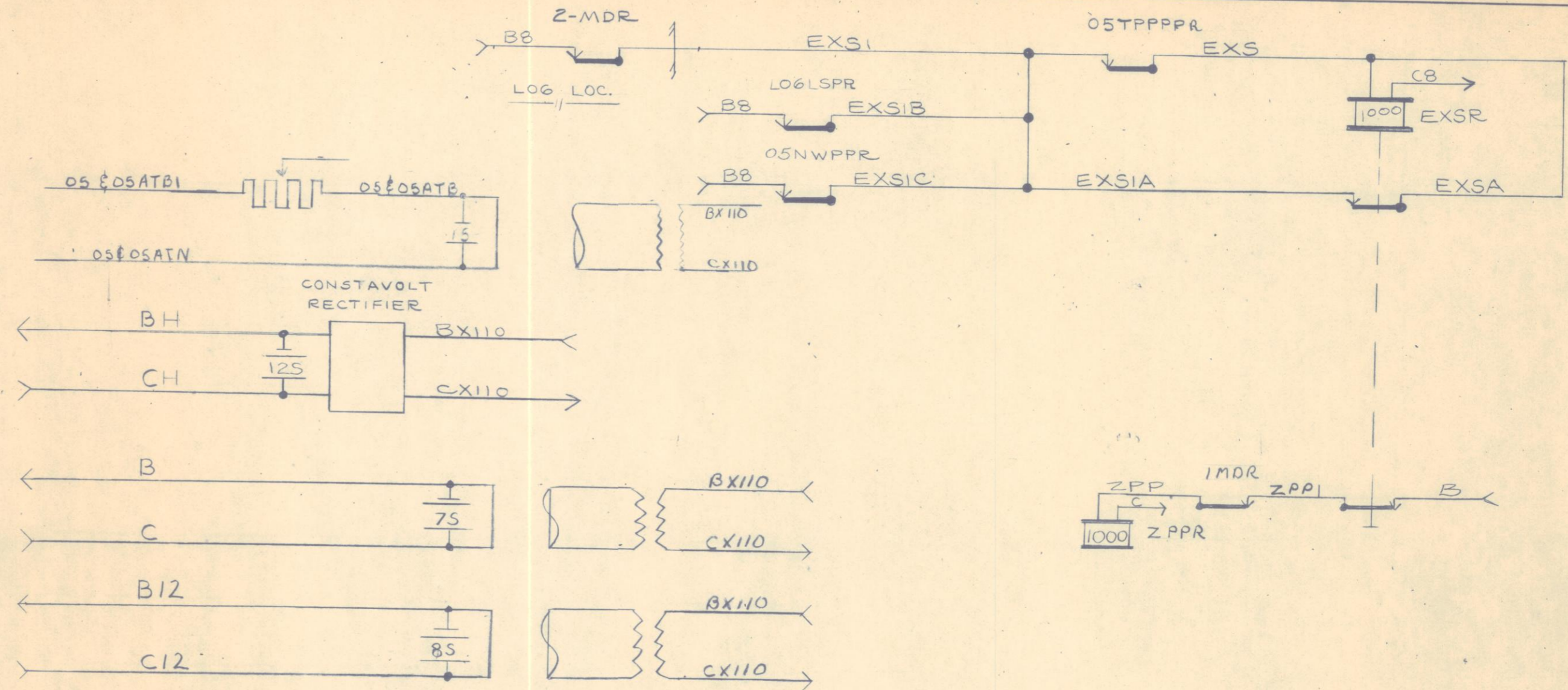
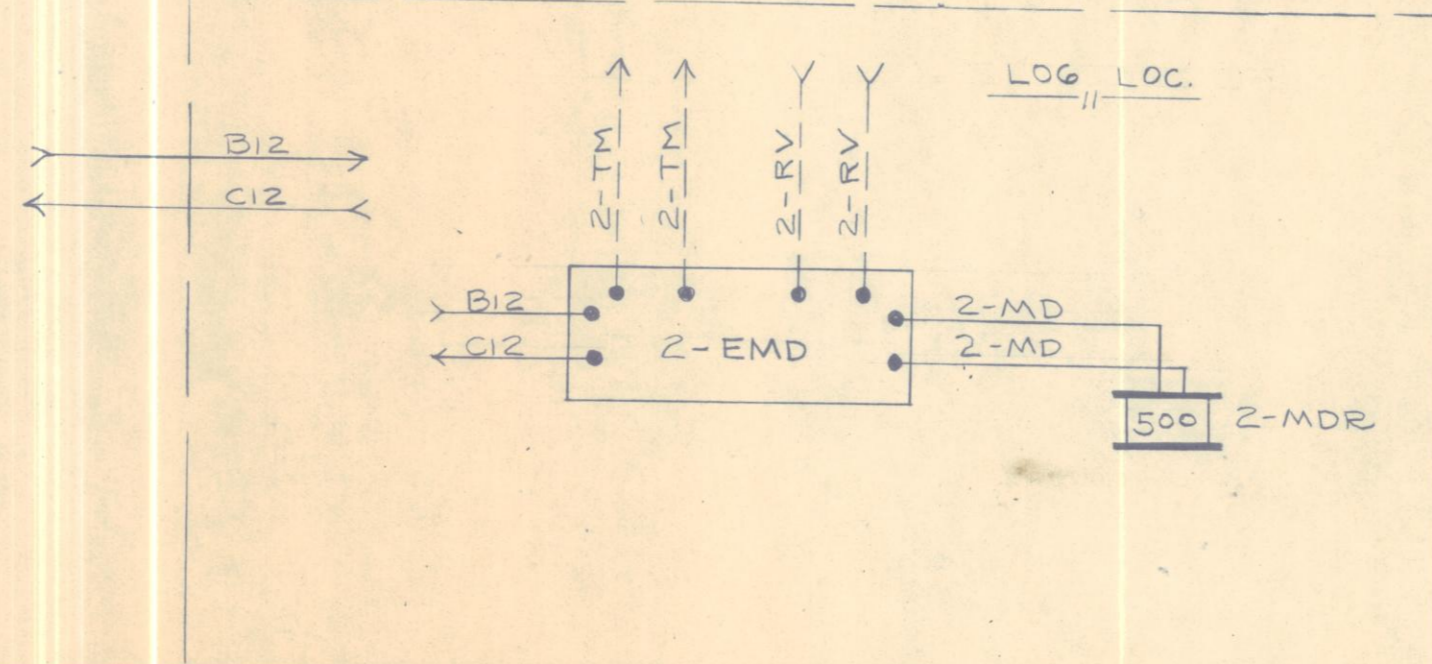
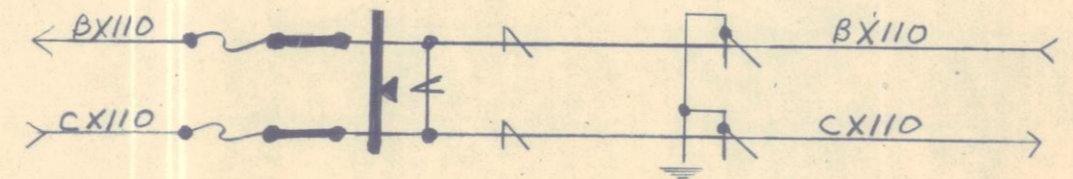
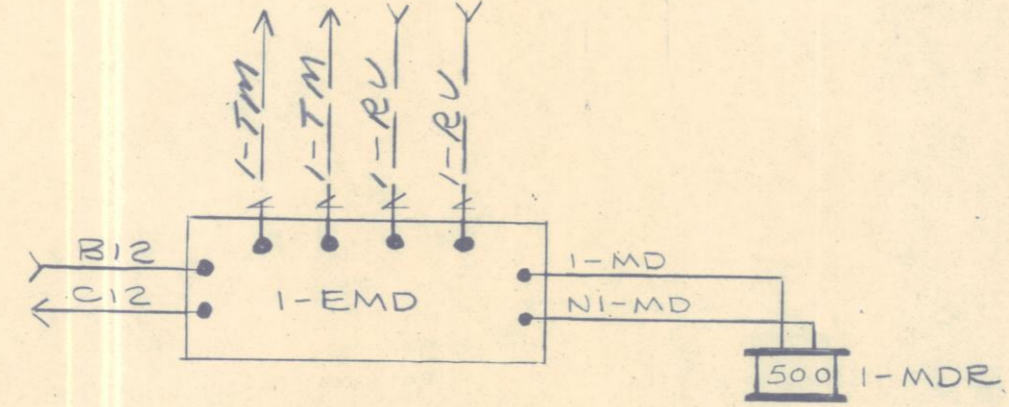
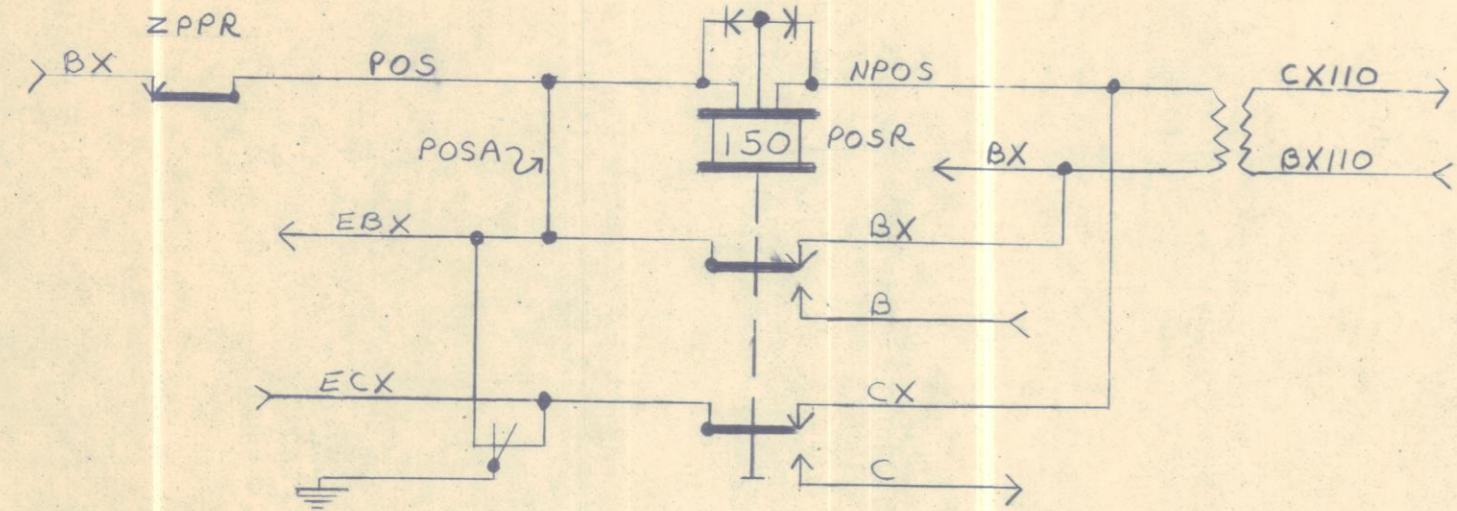

3-21-78
REV. AS
IN SERVICE
3-3-78 PER RWD
ASC JFS

(PROPOSED)
ERIE LACKAWANNA RAILWAY COMPANY
OFFICE OF CHIEF SIGNAL ENGINEER
CIRCUITS AT

"GI" SHARPSVILLE, PA.

SHEET 12 OF 15 SHEETS

1ST DIST. MAHONING

DIVISION SHEET # 72

6502-0841

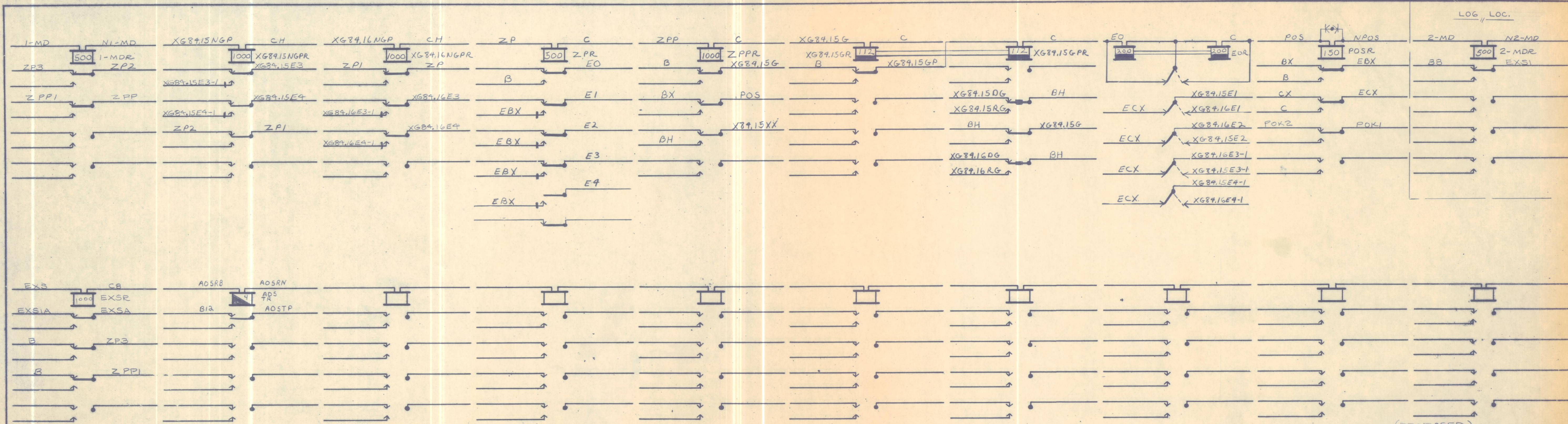

LOG // LOC.

(PROPOSED)
 ERIE-LACKAWANNA RAILWAY COMPANY
 OFFICE OF CHIEF SIGNAL ENGINEER
 CIRCUITS AT

"GI" SHARPSVILLE, PA.

3-21-78
 REV. AS
 IN SERVICE
 3-3-78
 PER RHD ASC JFS

SHEET 15 OF 15 SHEETS

1ST DIST MAHONING DIVISION SHEET # 72
 6502-0841